



FILTER • LAB



BARCELONA
1748

GENERAL CATALOGUE



Catálogo General FILTER-LAB 2017

Catalogue data

Title: "FILTER-LAB General Catalogue 2017"
Published by: Filtros Anioia, S.A. (Barcelona)
Creation, design and edition: Toni Mesquida

Copyright © 2017 by Filtros Anioia, S.A.

The total or partial reproduction of this catalogue is only allowed with the express authorization of Filtros Anioia, S.A.

Copies: 3.000 units in spanish
3.000 units in english





PRESENTATION

Dear Customer,

Since the date of our inception, 121 years ago, **FILTROS ANOIA, S.A.** has remained true to its values as a company with an own production plant of laboratory and process technical filter papers. Our industrial tradition is well present in the corporative philosophy until at the end of the 90s of the past century the world experienced a globalization process that has brought us to develop, at the same time, an important commercial activity with presence of our products in up to 129 countries and in every productive, development and investigation sectors.

Nowadays, **FILTROS ANOIA, S.A.** is a recognized Company, with an important international projection and, above everything, with an interesting future to go.

It is in this exact moment that we've decided to edit our new FILTER-LAB General Catalogue 2017. A technical publication that gathers one of the most wide laboratory filtration spectrum that embraces from microfiltration with membranes or syringe filters, the standard filtration with filter paper or even the use of special papers, nylon meshes or non woven filters. The information about the applications of the products occupies a good part of its nearly 180 pages.

As a complement to this work, we advise to connect with our website www.fanoia.com or contact us by e-mail at fanoia@fanoia.com where our professional team will be glad to kindly help you.

Thank you for your trust in us.

Barcelona, July 8th. 2017



Marc Sala i Escardó
President



CONTACT

Postal Address-Expeditions

FILTROS ANOIA

camí de Baix s/n

08776 Sant Pere de Riudebitlles (Bcn), Spain

Tel.: +34 93 899 50 36

e-mail: fanoia@fanoia.com

Fiscal Address

FILTROS ANOIA, S.A.

camí de Baix s/n

08776 Sant Pere de Riudebitlles (Bcn), Spain

Tel.: +34 93 899 50 36

NIF: ES A60628674

e-mail: administracion@fanoia.com

Shipping/order management: -
customerservice@fanoia.com

Expeditions: **Octavio Mollón**
octavio@fanoia.com

Accounting: **Carmen Carrasco**
carne@fanoia.com

Products index



FILTER PAPERS

- Quantitative analysis | 16
- Hardened quantitative analysis | 20
- General use qualitative analysis | 22
- Analytical grade qualitative analysis | 26



FILTER PAPER IN REAMS ABSORBENT PAPER WITH POLYETHYLENE

- Filter paper in reams | 32
- Absorbent paper with polyethylene | 33
- Absorbent paper with polyethylene dispenser | 31



GLASS AND QUARTZ MICROFIBER FILTERS

- Glass microfiber without binders | 34
- Glass microfiber with binders | 36
- Quartz microfiber | 37

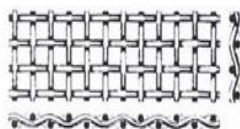

MESH FILTERS NON WOVEN FILTERS

- Stainless steel mesh filters | 44
- Nylon mesh filters | 46
- Non woven filters | 43



pH INDICATORS

- pH paper strips | 66
- pH plastic strips | 66
- pH paper rolls | 66
- Moisture sensitive paper | 66
- Litmus paper | 67
- Qualitative detection tests | 67
- Recharges | 67



FILTRATION EQUIPMENT

- Stainless steel filtration manifolds | 150
- Stainless steel funnels | 149
- Nylon manifolds | 148
- Polycarbonate equipment | 152
- Glass filtration equipment | 155
- Vacuum pumps | 146-147
- Accessories | 156-157



SYRINGE FILTERS

- Cellulose acetate | 112
- Glass fiber | 116
- Glass fiber prefilter + Cel. acetate. | 114
- Glass fiber prefilter + Nylon | 114
- Polyethersulfone (PES) | 118
- Polyamide (Nylon) | 120
- PTFE hydrophilic | 124
- PTFE hydrophobic | 122
- PVDF hydrophilic | 126
- PVDF hydrophobic | 126
- Polypropylene (PP) | 128
- Regenerated Cellulose (RC) | 130
- Venting filters | 143

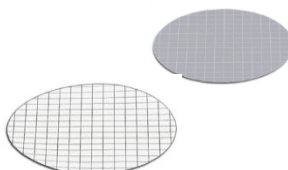

MEMBRANE FILTERS

- Cellulose acetate | 84
- Cellulose mixed esters | 86
- Blotting membranes | 90
- Polyamide (Nylon) | 94
- Polyethersulfone | 96
- PTFE | 98
- Polypropylene (PP) | 100
- PVDF | 102
- Polycarbonate | 104
- Regenerated Cellulose | 106
- Polyester | 108



MEMBRANE FILTERS IN ROLLS

- Membrane filters dispenser | 92
- Membrane filters in rolls | 92



FILTRATION VIALS

- Filtration vials | 133

Products index



SPECIAL FILTER PAPERS

Filter paper with diatoms | 38
 Phase separator paper | 39
 Paper free of P and K, low in N | 40
 Active carbon filter paper | 41
 Black filter paper | 41
 Fat analysis filter paper | 42
 Paper for normalized analysis | 30

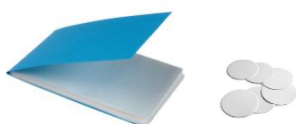

SPECIAL PRODUCTS

Blocks of drying samples paper | 70
 Joseph paper | 70
 Lens cleaning paper | 71
 Cytological analyses paper | 71
 Smelling tests paper | 72
 Antibiotic test paper | 73



CELLULOSE STOPPERS

Cellulose stoppers | 62



FILTRATION SYSTEM WATERVAC 100

Direct transfer vacuum pump | 158
 Magnetic, polyethersulfone and stainless steel funnels and microbiological monitors | 159-163
 Accessories | 164



THIMBLES

Cellulose extraction thimbles | 48
 Glass microfiber thimbles | 50
 Quartz microfiber thimbles | 51



HAND DRYER PAPER

Hand dryer paper | 31
 Dispenser | 31



FILTRATION ASSISTANTS

Quantitative cellulose fibers | 74
 Qualitative cellulose fibers | 74
 Quantitative cellulose trimmings | 74
 Qualitative cellulose trimmings | 74
 Soils with diatoms | 74



FILTER HOLDERS

13 mm diameter | 136-137
 25 mm diameter | 138-140
 47 mm diameter | 141-142



DIVERSE USE PAPERS

Chromatography papers | 52
 Blotting techniques papers | 54
 Absorbent paper for paper industry | 55
 Seed germination paper | 56
 Drying paper | 58
 Sterilization paper | 60
 Protection paper for stretchers | 61



WEIGHING OF PRODUCTS

Weighing paper | 68
 Weighing containers | 68
 Weighing trays | 69
 Aluminum paper | 69



TECHNICAL FILTER PAPERS FILTER SHEETS PRESS FILTERS

Technical filter papers | 75
 Filter sheets | 78
 Press filters | 79



MICROBIOLOGICAL MONITORS AND FILTRATION UNITS

Microbiological monitors | 153
 Filtration units | 144

FILTROS ANOIA in the world

Nowadays, Filtros Anioia, S.A. exports its products to more than 100 countries around the world, one of them are USA, Germany, Canada, UK, Finland, Switzerland, France, South Korea, Chile or Italy, for example.

Our filters are used in every single sector: pharmaceutical, cosmetically, drinks, foods, chemical, construction, metallurgical, environmental, university, stockbreeding, agriculture, mining, investigation, wine, textile, etc.



- Fabrication, converting and headquarter
- Distributors

Quality control and technical definitions for filter paper

Weight in grams (grammage)

Unit of measurement: gr/m²

Expresses the weight in grams of a square meter of manufactured paper. Standard applied: UNE-EN-ISO 536:1995.

According to which a sample of paper between 500 and 1000cm² is weighed on precision scales with a margin of error of 0.5%. Later, the area is calculated and the weight in grams is determined.

$$g = (m/A) \times 10.000$$

where: **m** is the mass of the sample in g
A is the area of the sample in cm²

Thickness

Unit of measurement: mm

Is the distance between both faces of the paper.

Standard applied: UNE-EN 20534 ISO 534:1988

To determine this parameter it used a micrometer that tests static load.

Apparent density

Unit of measurement: g/cm³

Expresses the apparent density according to the following calculation:

Standard applied: UNE-EN 20534 ISO 534:1988

$$\text{Apparent density (g/cm}^3\text{)} = \frac{\text{Weight in grams (g/m}^2\text{)} \times 1000}{\text{Thickness (mm)}}$$

Ash content

Unity of measurement: %

Calculated from the difference of weight between the calcination residue obtained with a muffle at 800°C in a platinum or porcelain crucible and the 10 grams sample of filter paper completely free of moisture, according to the calculation:

Standard applied: UNE 57019

$$x = (G_1/G) \times 100$$

where: **G** is the weight of the hard dry sample in g
G₁ is the weight of the calcination residue in g
x is the ash content in %

Filtration

Is a denomination used as internal way according to the filtration speed of each quality.

There are 7 different kind of filtration:

- Extra-fast
- Very fast
- Fast
- Medium
- Medium-slow
- Slow
- Very slow

Pore size

Standard measurement: μm

The pore is calculated by the medium values obtained with a pore measurer. It is a parameter used in filter paper.

Klemm method (capillary rise of the water)

Unit of measurement: mm/10 min.

Measures the height reached by distilled water at 20°C through a trip of paper 200mm long and 15mm wide, immersed 10mm, for a period of 10 minutes.

Standard applied: UNE 57044



Quality control and technical definitions for filter paper

Absorption in area

Measure unit: gr/m²

Expresses the weight in grams per square meter of manufactured paper.

Standard applied: ISO 5269-1: 1998

It is obtained from the difference in weight between a sample of 40 x 40 mm, after an immersion in distilled water for 2 seconds at 23°C, leaving it to drip for 30 seconds and holding it by one corner and the same sample but dry, according to the equation:

$$A = (m_2 / m_1) F$$

where: m₁ is the dry mass of the sample in gr.

m₂ is the moist mass of the sample

F = 10.000/surface of test*

*16 cm²

Retention

Unit of measurement: µm

Corresponds to the lower measurement of the size of the particles stopped by the filter. This parameter is very much used in filters with considerable capacity for depth retention of particles by various physical and chemical means (glass and quartz microfiber filters most of all).

Maximum temperature of use

Unit of measurement: °C

Marks a limit of temperature of use for the filters from which the materials start to lose its customary properties.

DOP penetration

Unit of measurement: %

Measures the efficiency in % of a filter with respect to the retention of particles against the passing of a mist of dioctyle ophthalate and calculated by means of photometry. The approximate size of particles is dioctyle ophthalate 0.3 µm.

Calculation of the pH of the aqueous extracts

Unit of measurement: pH

Standard applied: UNE 57-032-91

Determines the pH vale of the samples of manufactured filter paper or absorbent paper.

Resistance to traction in wet state

Measuring unit: kN/m

Standard applied: UNE 57030-94, ISO 3781

Determines the resistance to the moist state in the filter paper measuring the resistance that a 180 mm length and 10mm width strip can support in a period of time of 10 minutes.

Tensile strength

Measuring unit: kN/m

Standard applied: UNE 57028

Is a paper strip of 15 mm width and 180 mm length that is applied with strength that increases in an uniform and progressive way. The measure is taken at the same moment that the break. This parameter is measured in a longitudinal sense (SL) and also in a transversal sense (ST).

Flow rate

Measuring units: l/m²/h or m³/m²/h

Standard applied: intern

This unit measure the pass of the water in litres per surface unit (m²) and time (h) for filtering plats and filter papers. In the case of more porous filters as the non woven filters, it measures the flow rate in m³.



Quality control and definitions for membrane filters

Bubble point with water (minimum value)

Measuring unit : bar

Applied Standard: ASTM F-316, DIN 58355

A membrane filter is humidified with water (hydrophilic) or isopropanol (hydrophobic membranes). Later, a pressure with air is applied in the other face of the membrane. The value in bar is obtained in the moment when the air bubbles cross. The filter's pore is designated as "bubble point". Usually this parameter is used to assure the integrity of the membrane filter's porosity.

Flow rate with water or isopropanol

Measuring unit: ml/min/cm²

Applied Standard: DIN 58355

Is the water's volume in ml per unity of time (min) capable to pass as unity of surface (cm²) to a pressure of 0.9 bar. In the case of hydrophobic filters the liquid is isopropanol.

Extractables with water

Measuring unit: %

Applied Standard: DIN 53141/6

States the weight loss of a membrane after being 30 minutes in boil water. It is calculated by its difference of weight.

Flow rate with air

Measuring unit: ml/min/cm²

Applied Standard: -

Is the volume in air that is capable to cross a membrane with a constant pressure of 0.7 bar.

Temperature of use

Measuring unit: °C

Is the maximum temperature from where the membrane filter losses its habitual properties.

Maximum work pressure

Measuring unit: psi

Denotes the maximum pressure that a membrane can support before crashing.

Reaction to water

The affinity (hydrophily) or the repulsion (hydrophobia) to the water is an important piece of information at the moment to chose the most adequate membrane for the filtration of an aqueous sample.

Porosity

Measuring unit: %

In some membranes, as polycarbonate membranes, is possible to determine the percentage of the surface that the pores use.

Absorption of proteins

Measuring : µg/cm²

The majority of the materials that are manufactured for the membranes have the absorption of proteins. The quantity of bovine serum of albumin (BSA) is determined capable of holding back per unit of surface.

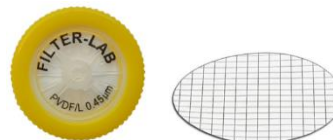

Quality control and definitions for syringe and membrane filters

Hold-up volume

Measuring unit: μl

Is the volume of sample that remains caught inside the syringe filter's case without any possibilities to be recovery.

Filtration area

Measuring unit: cm^2

Is the effective surface of the membrane filter that it is hosted inside the dispositive case.

Maximum work pressure

Measuring unit: bar

Is the maximum pressure that a membrane filter can reach before breaking the membrane inside the case.

Input / Output connectors

A syringe filter is a dispositive that has an input and output connection.

Input: FILTER-LAB® syringe filters have the entrance luer lock socket type, in other words, perfectly adapted to connect universal syringes with a luer lock male exit.

Output: FILTER-LAB® syringe filters have exit luer slip male exit adapted to connect a needle o for a direct exit of the filtered sample.

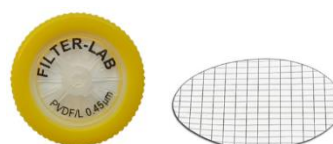

Filtration scheme for filter papers FILTER-LAB®

		RANGE OF FILTERS				
		QUANTITATIVE	HARDENED QUANTITATIVE	GENERAL USE QUALITATIVE	ANALYTICAL QUALITATIVE	TEHNICAL FILTER PAPER
SPEED FILTRATION	EXTRA-FAST	1232		1320		1518/156
	VERY FAST	1235	2235	1300/80 1318 1303	1248	1518/140W 1526P
	FAST	1238		1326	1249	1301/140
	MEDIUM	1240	2240	1300G	1250	1526 1055
	MEDIUM-SLOW	1242			1252 1258	1300/110
	SLOW	1244	2244		1254	F150
	VERY SLOW	1246			1256	SM 90

FILTER-LAB filters coding system

FILTRATION

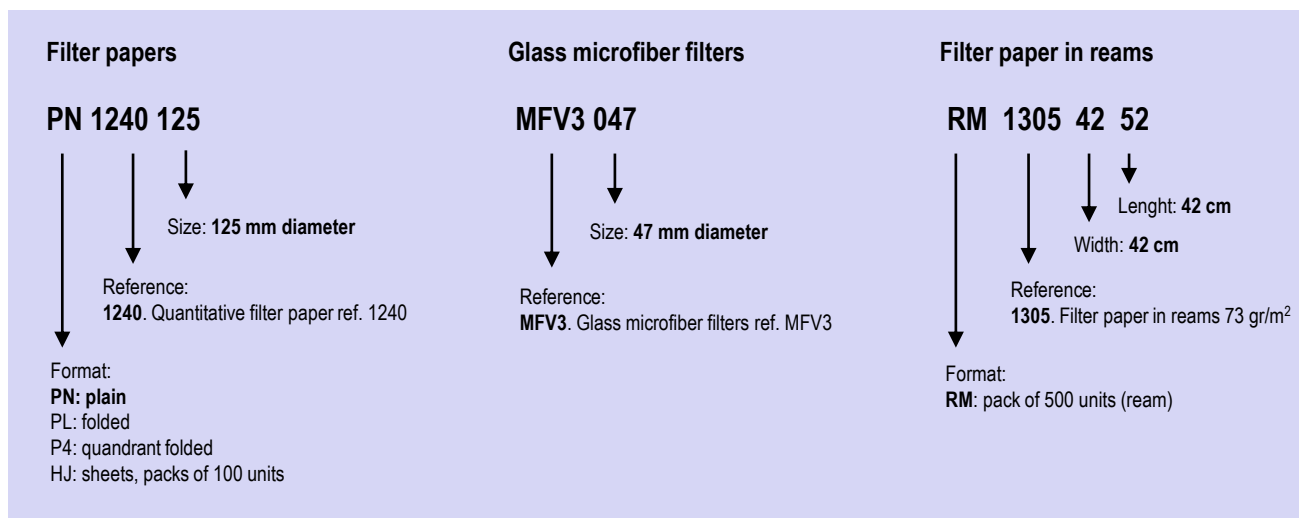

MICROFILTRATION

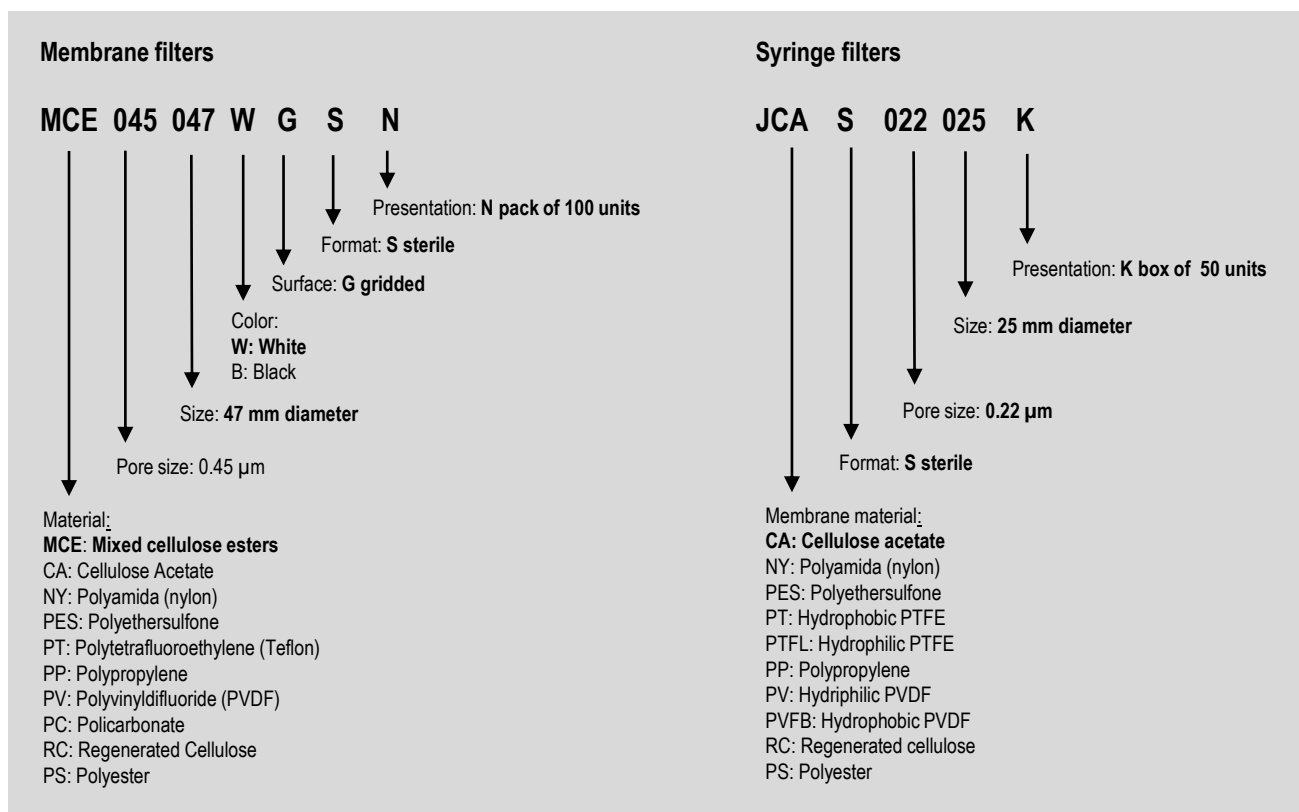

Quantitative filter paper

Ash content that is less than 0.01%. Critical analysis and gravimeters.



Description

Filter paper for quantitative analysis FILTER-LAB® are made under the strictest requirements of quality not only of the raw materials used but also of the conditions in which the production processes take place.

For its manufacture we use cellulose fibers and very pure cotton linters whose content in alpha cellulose is virtually 100%. At any rate, the cellulose fibers in its natural state contain small quantities of organic and inorganic impurities. It is because of this that these paper filter papers require a special production process.

Once the filter paper is manufactured in the desired physical conditions (weight in grams, thickness, speed filtration, etc.) a washing process with acids is initiated (generally HF and HCl) which concludes with a final cleaning with demineralized water. We get two important properties in the process as the high resistance to the moist state and the ash content is less than 0.01%.

Because of all this, these filters are specially suitable for filtration with Büchner funnels in quantitative analyses since they meet the requirements of international standards with regard to ash content.

This range is formed by 7 qualities with different filtration and retention:

Technical specifications

Ref.	Filtration	Grammage	Thickness	Pore size	Ashes
		g/m ²	mm	µm	%
1232	Extra-fast	85	0.220	25-35	< 0.01
1235	Very fast	85	0.200	25-30	< 0.01
1238	Fast	85	0.200	20-25	< 0.01
1240	Medium	85	0.200	14-18	< 0.01
1242	Medium-slow	70	0.160	7-9	< 0.01
1244	Slow	85	0.170	2-4	< 0.01
1246	Very slow	100	0.200	1-3	< 0.01

APPLICATIONS

Ref. 1232. Extra fast filtration

- Filtration of very thick precipitations and jelly precipitations.
- Photometrical analysis in juicy samples.

Ref. 1235. Very fast filtration

- Filtration of thick precipitates such as Fe (OH)₃, Al (OH)₃, Si O₂, Cr (OH)₃
- Gravimetric analysis of particles of present particles in the air.
- Determination of the content of silica in Steel and iron.
- Control of the desertion in petroleum fractions.

Ref. 1238. Fast filtration

- Filtration of silver sulfides, arsenic, cadmium, iron, lead and manganese.
- Analyses of food
- Analyses of floors
- Determination of heavy metals in the water

Ref. 1240. Medium filtration

- Filtration of medium-sized particles: calcium oxalate, some metallic sulfates and others
- Analyses of the dimension of the grain of cement by Blaine's test and Dickerhoof system.
- Calculation of Mg in waters or as quality standard in gravimeters.
- Determination of the content of some kind of cements.
- Analyses of food

Ref. 1242. Medium-slow filtration

- Analyses of different components of the cement, moods, and aqueous extracts from floors.
- Determination of oils in aqueous samples.
- Determination of sediments in milk.
- Capture of radionuclide and traces of elements from the atmosphere.

Ref. 1244. Slow filtration

- Retention of fine or semicollodial particles such as barium sulfate and lead in cold.
- Retention of particles of calcium carbonate samples.
- Analysis of insoluble particles in oils and animal or vegetal fats.

Ref. 1246. Very slow filtration

- Retention of very fine particles as cooper oxide.
- Fine mud samples with particles filtration.

Formats and dimensions



12.5*	12.7*	12.8*	25	42.5	47	50	55	70	90	110	125	150	185	200	240	250	270	320
-------	-------	-------	----	------	----	----	----	----	----	-----	-----	-----	-----	-----	-----	-----	-----	-----

Dimensions: Diameter in mm

Presentation: Packs of 100 units

* Packs of 1.000 units



70	90	110	125	150	185	200	240	250	270	320
----	----	-----	-----	-----	-----	-----	-----	-----	-----	-----

Dimensions: Diameter in mm

Presentation: Packs of 100 units



203 x 254	460 x 570
-----------	-----------

Dimensions: Measures in mm

Presentation: Packs of 100 units

Other formats and dimensions available under demand.

INFORMATION FOR ORDERS. Quantitative analysis filter paper
Ref. 1232. Extra-fast filtration

Size mm Ø	Plain	Folded	Sheets	units/box
25	PN1232025	-	-	100
42.5	PN12320425	-	-	100
47	PN1232047	-	-	100
50	PN1232050	-	-	100
55	PN1232055	-	-	100
70	PN1232070	PL1232070	-	100
90	PN1232090	PL1232090	-	100
110	PN1232110	PL1232110	-	100
125	PN1232125	PL1232125	-	100
150	PN1232150	PL1232150	-	100
185	PN1232185	PL1232185	-	100
200	PN1232200	PL1232200	-	100
240	PN1232240	PL1232240	-	100
250	PN1232250	PL1232250	-	100
270	PN1232270	PL1232270	-	100
320	PN1232320	PL1232320	-	100
203 x 254	-	-	HJ1232203254	100
460 x 570	-	-	HJ1232460570	100

Ref. 1235. Very fast filtration

Size mm Ø	Plain	Folded	Sheets	units/box
25	PN1235025	-	-	100
42.5	PN12350425	-	-	100
47	PN1235047	-	-	100
50	PN1235050	-	-	100
55	PN1235055	-	-	100
70	PN1235070	PL1235070	-	100
90	PN1235090	PL1235090	-	100
110	PN1235110	PL1235110	-	100
125	PN1235125	PL1235125	-	100
150	PN1235150	PL1235150	-	100
185	PN1235185	PL1235185	-	100
200	PN1235200	PL1235200	-	100
240	PN1235240	PL1235240	-	100
250	PN1235250	PL1235250	-	100
270	PN1235270	PL1235270	-	100
320	PN1235320	PL1235320	-	100
203 x 254	-	-	HJ1235203254	100
460 x 570	-	-	HJ1235460570	100

Ref. 1238. Fast filtration

Size mm Ø	Plain	Folded	Sheets	units/box
25	PN1238025	-	-	100
42.5	PN12380425	-	-	100
47	PN1238047	-	-	100
50	PN1238050	-	-	100
55	PN1238055	-	-	100
70	PN1238070	PL1238070	-	100
90	PN1238090	PL1238090	-	100
110	PN1238110	PL1238110	-	100
125	PN1238125	PL1238125	-	100
150	PN1238150	PL1238150	-	100
185	PN1238185	PL1238185	-	100
200	PN1238200	PL1238200	-	100
240	PN1238240	PL1238240	-	100
250	PN1238250	PL1238250	-	100
270	PN1238270	PL1238270	-	100
320	PN1238320	PL1238320	-	100
203 x 254	-	-	HJ1238203254	100
460 x 570	-	-	HJ1238460570	100

Ref. 1240. Medium filtration

Size mm Ø	Plain	Folded	Sheets	units/box
12.5	PN12400125	-	-	1000
12.7	PN12400127	-	-	1000
12.8	PN12400128	-	-	1000
25	PN1240025	-	-	100
42.5	PN12400425	-	-	100
47	PN1240047	-	-	100
50	PN1240050	-	-	100
55	PN1240055	-	-	100
70	PN1240070	PL1240070	-	100
90	PN1240090	PL1240090	-	100
110	PN1240110	PL1240110	-	100
125	PN1240125	PL1240125	-	100
150	PN1240150	PL1240150	-	100
185	PN1240185	PL1240185	-	100
200	PN1240200	PL1240200	-	100
240	PN1240240	PL1240240	-	100
250	PN1240250	PL1240250	-	100
270	PN1240270	PL1240270	-	100
320	PN1240320	PL1240320	-	100
203 x 254	-	-	HJ1240203254	100
460 x 570	-	-	HJ1240460570	100

INFORMATION FOR ORDERS. Quantitative analysis filter paper

Ref. 1242. Medium-slow filtration

Size mm Ø	Plain	Folded	Sheets	units/box
25	PN1242025	-	-	100
42.5	PN12420425	-	-	100
47	PN1242047	-	-	100
50	PN1242050	-	-	100
55	PN1242055	-	-	100
70	PN1242070	PL1242070	-	100
90	PN1242090	PL1242090	-	100
110	PN1242110	PL1242110	-	100
125	PN1242125	PL1242125	-	100
150	PN1242150	PL1242150	-	100
185	PN1242185	PL1242185	-	100
200	PN1242200	PL1242200	-	100
240	PN1242240	PL1242240	-	100
250	PN1242250	PL1242250	-	100
270	PN1242270	PL1242270	-	100
320	PN1242320	PL1242320	-	100
203 x 254	-	-	HJ1242203254	100
460 x 570	-	-	HJ1242460570	100

Ref. 1244. Slow filtration

Size mm Ø	Plain	Folded	Sheets	units/box
25	PN1244025	-	-	100
42.5	PN12440425	-	-	100
47	PN1244047	-	-	100
50	PN1244050	-	-	100
55	PN1244055	-	-	100
70	PN1244070	PL1244070	-	100
90	PN1244090	PL1244090	-	100
110	PN1244110	PL1244110	-	100
125	PN1244125	PL1244125	-	100
150	PN1244150	PL1244150	-	100
185	PN1244185	PL1244185	-	100
200	PN1244200	PL1244200	-	100
240	PN1244240	PL1244240	-	100
250	PN1244250	PL1244250	-	100
270	PN1244270	PL1244270	-	100
320	PN1244320	PL1244320	-	100
203 x 254	-	-	HJ1244203254	100
460 x 570	-	-	HJ1244460570	100

Ref. 1246. Very slow filtration

Size mm Ø	Plain	Folded	Sheets	units/box
25	PN1246025	-	-	100
42.5	PN12460425	-	-	100
47	PN1246047	-	-	100
50	PN1246050	-	-	100
55	PN1246055	-	-	100
70	PN1246070	PL1246070	-	100
90	PN1246090	PL1246090	-	100
110	PN1246110	PL1246110	-	100
125	PN1246125	PL1246125	-	100
150	PN1246150	PL1246150	-	100
185	PN1246185	PL1246185	-	100
200	PN1246200	PL1246200	-	100
240	PN1246240	PL1246240	-	100
250	PN1246250	PL1246250	-	100
270	PN1246270	PL1246270	-	100
320	PN1246320	PL1246320	-	100
203 x 254	-	-	HJ1246203254	100
460 x 570	-	-	HJ1246460570	100

Hardened quantitative analysis filter paper

Ash content lower than 0.01%. High moist resistance.



Description

Its main characteristic, furthermore to have a low ashes content under 0.01% it is its high resistance to moist state, for this reason is recommended its use in pressure filtrations or in Büchner funnels in gravimetric analysis of samples with mild acidic or alkaline rating.

Likewise, its marked evenness on the surface of the filter allows one to recover most precipitates without the fibers adhering to them.

Technical specifications

Ref.	Filtration	Grammage g/m ²	Thickness mm	Pore µm	Ashes %
2235	Very fast	85	0.200	25-30	< 0.01
2240	Medium	85	0.200	15-17	< 0.01
2244	Slow	85	0.170	2-4	< 0.01

Formats and dimensions



25	42.5	47	50	55	70	90	110	125	150	185	200	240	250	270	320
----	------	----	----	----	----	----	-----	-----	-----	-----	-----	-----	-----	-----	-----

Dimensions: diameter in mm
Presentation: Packs of 100 units



70	90	110	125	150	185	200	240	250	270	320
----	----	-----	-----	-----	-----	-----	-----	-----	-----	-----

Dimensions: diameter in mm
Presentation: Packs of 100 units



203 x 254	460 x 570
-----------	-----------

Dimensions: diameter in mm
Presentation: Packs of 100 units

Others formats and dimensions available on demand.

APPLICATIONS

Ref. 2235. Very fast filtration

- Gravimetric analysis with pressure funnel.
- Analysis of creams and animal fats.
- Analysis of some minerals and chemical products.

Ref. 2240. Medium filtration

- Analysis of samples that are mildly alkaline or acidic.

Ref. 2244. Slow filtration

- Determination of metals.
- Recovery of precipitations in the filter's surface.

INFORMATION FOR ORDERS. Quantitative analysis filter paper

Ref. 2235. Very fast filtration

Size mm Ø	Plain	Folded	Sheets	units/box
25	PN2235025	-	-	100
42.5	PN22350425	-	-	100
47	PN2235047	-	-	100
50	PN2235050	-	-	100
55	PN2235055	-	-	100
70	PN2235070	PL2235070	-	100
90	PN2235090	PL2235090	-	100
110	PN2235110	PL2235110	-	100
125	PN2235125	PL2235125	-	100
150	PN2235150	PL2235150	-	100
185	PN2235185	PL2235185	-	100
200	PN2235200	PL2235200	-	100
240	PN2235240	PL2235240	-	100
250	PN2235250	PL2235250	-	100
270	PN2235270	PL2235270	-	100
320	PN2235320	PL2235320	-	100
203 x 254	-	-	HJ2235203254	100
460 x 570	-	-	HJ2235460570	100

Ref. 2240. Medium filtration

Size mm Ø	Plain	Folded	Sheets	units/box
25	PN2240025	-	-	100
42.5	PN22400425	-	-	100
47	PN2240047	-	-	100
50	PN2240050	-	-	100
55	PN2240055	-	-	100
70	PN2240070	PL2240070	-	100
90	PN2240090	PL2240090	-	100
110	PN2240110	PL2240110	-	100
125	PN2240125	PL2240125	-	100
150	PN2240150	PL2240150	-	100
185	PN2240185	PL2240185	-	100
200	PN2240200	PL2240200	-	100
240	PN2240240	PL2240240	-	100
250	PN2240250	PL2240250	-	100
270	PN2240270	PL2240270	-	100
320	PN2240320	PL2240320	-	100
203 x 254	-	-	HJ2240203254	100
460 x 570	-	-	HJ2240460570	100

Ref. 2244. Slow filtration

Size mm Ø	Plain	Folded	Sheets	units/box
25	PN2244025	-	-	100
42.5	PN22440425	-	-	100
47	PN2244047	-	-	100
50	PN2244050	-	-	100
55	PN2244055	-	-	100
70	PN2244070	PL2244070	-	100
90	PN2244090	PL2244090	-	100
110	PN2244110	PL2244110	-	100
125	PN2244125	PL2244125	-	100
150	PN2244150	PL2244150	-	100
185	PN2244185	PL2244185	-	100
200	PN2244200	PL2244200	-	100
240	PN2244240	PL2244240	-	100
250	PN2244250	PL2244250	-	100
270	PN2244270	PL2244270	-	100
320	PN2244320	PL2244320	-	100
203 x 254	-	-	HJ2244203254	100
460 x 570	-	-	HJ2244460570	100

General use qualitative analysis filter paper

Used for filtrations of routine in all kinds of laboratories



Description

These filter papers, manufactured with first quality pure cellulose, are used in all types of laboratories in routine works where needed a simple solid-liquid separation with maximum time savings. They are, therefore, rapid filtration or extra-rapid. Some have a rough surface and a high basis weight to increase their load capacity.

They are used in laboratories, in the food, pharmaceutical, beverage, schools, universities, chemical, water laboratories, etc..

All are supplied flat format, folded and sheets.

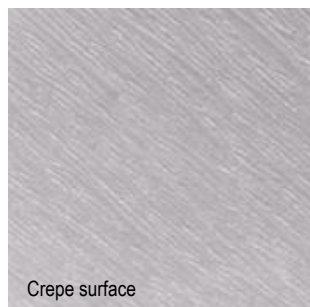

Crepe surface



Smooth surface

Technical specifications

Ref.	Speed/Surface/Thickness	Grammage	Thickness	Pore	Ashes
		g/m ²	mm	µm	%
1300/80	Very fast, smooth, medium	80	0.185	43-48	< 0.15
1320	Extra-fast, smooth, thick	160	0.470	60-68	< 0.15
1318	Very fast, crepe, thick	155	0.450	35-40	< 0.20
1303	Very fast, crepe, thin	64	0.165	34-42	< 0.15
1300G	Mediu-fast, smooth, medium	85	0.180	14-22	< 0.15
1326	Fast, crepe, medium	90	0.330	26-34	< 0.20

APPLICATIONS

Ref. 1300/80. Extra fast filtration, smooth.

- Routine laboratory leaks of various types: industry, hospitals, teaching, research, water, etc.
- Determination of sucrose in the sugar industry.
- Pre-filtration of filter paper samples prior greater retention.
- Quality control in the manufacture of zinc.

Ref. 1320. Extra fast filtration, smooth, thick.

- Filtration of viscous liquids, essences, syrups and dense oils.
- Filtration of liquids with high load precipitates.

Ref. 1318. Very fast filtration, crepe, thick.

- Filtration of viscous liquids, essences, syrups and dense oils.
- Filtration of samples of nectars.
- Precious metal recovery.

Ref. 1303. Very fast filtration, crepe, fine.

- Determination of sucrose in the sugar cane industry by the method of adding lead acetate.

Ref. 1300G. Medium-fast filtration, smooth.

- Routine filtrations where needed greater retention of particles with the filter paper 1300/80.

Ref. 1326 Fast filtration, crepe.

- Filtrations with high particulate loading
- Determination of sucrose in the sugar industry

Formats and dimensions



25	42.5	47	50	55	70	90	110	125	130	150	185	200	240	250	270	300	320	350	400	450	500	650	800	1000
----	------	----	----	----	----	----	-----	-----	-----	-----	-----	-----	-----	-----	-----	-----	-----	-----	-----	-----	-----	-----	-----	------

Dimensions: diameter in mm
Presentation: Packs of 100 units



70	90	110	125	130	150	185	200	240	250	270	300	320	350	400	450	500	650	800	1000
----	----	-----	-----	-----	-----	-----	-----	-----	-----	-----	-----	-----	-----	-----	-----	-----	-----	-----	------

Dimensions: diameter in mm
Presentation: Packs of 100 units



203 x 254	460 x 570
-----------	-----------

Dimensions: diameter in mm
Presentation: Packs of 100 units

Others formats and dimensions available on demand.

INFORMATION FOR ORDERS. General use qualitative analysis filter paper
Ref. 1300/80. Very fast filtration

Size mm Ø	Plain	Folded	Sheets	units/box
25	PN1300025	-	-	100
42.5	PN13000425	-	-	100
47	PN1300047	-	-	100
50	PN1300050	-	-	100
55	PN1300055	-	-	100
70	PN1300070	PL1300070	-	100
90	PN1300090	PL1300090	-	100
110	PN1300110	PL1300110	-	100
125	PN1300125	PL1300125	-	100
130	PN1300130	PL1300130	-	100
150	PN1300150	PL1300150	-	100
185	PN1300185	PL1300185	-	100
200	PN1300200	PL1300200	-	100
240	PN1300240	PL1300240	-	100
250	PN1300250	PL1300250	-	100
270	PN1300270	PL1300270	-	100
320	PN1300320	PL1300320	-	100
350	PN1300350	PL1300350	-	100
400	PN1300400	PL1300400	-	100
450	PN1300450	PL1300450	-	100
500	PN1300500	PL1300500	-	100
650	PN1300650	PL1300650	-	100
800	PN1300800	PL1300800	-	100
1000	PN13001000	PL13001000	-	100
460 x 570	-	-	HJ1300460570	100

Ref. 1320. Extra-fast filtration

Size mm Ø	Plain	Folded	Sheets	units/box
25	PN1320025	-	-	100
42.5	PN13200425	-	-	100
47	PN1320047	-	-	100
50	PN1320050	-	-	100
55	PN1320055	-	-	100
70	PN1320070	PL1320070	-	100
90	PN1320090	PL1320090	-	100
110	PN1320110	PL1320110	-	100
125	PN1320125	PL1320125	-	100
130	PN1320130	PL1320130	-	100
150	PN1320150	PL1320150	-	100
185	PN1320185	PL1320185	-	100
200	PN1320200	PL1320200	-	100
240	PN1320240	PL1320240	-	100
250	PN1320250	PL1320250	-	100
270	PN1320270	PL1320270	-	100
320	PN1320320	PL1320320	-	100
350	PN1320350	PL1320350	-	100
400	PN1320400	PL1320400	-	100
450	PN1320450	PL1320450	-	100
500	PN1320500	PL1320500	-	100
650	PN1320650	PL1320650	-	100
800	PN1320800	PL1320800	-	100
1000	PN13201000	PL13201000	-	100
460 x 570	-	-	HJ1320460570	100

Ref. 1318. Very fast filtration, crepe, thick

Size mm Ø	Plain	Folded	Sheets	units/box
25	PN1318025	-	-	100
42.5	PN13180425	-	-	100
47	PN1318047	-	-	100
50	PN1318050	-	-	100
55	PN1318055	-	-	100
70	PN1318070	PL1318070	-	100
90	PN1318090	PL1318090	-	100
110	PN1318110	PL1318110	-	100
125	PN1318125	PL1318125	-	100
130	PN1318130	PL1318130	-	100
150	PN1318150	PL1318150	-	100
185	PN1318185	PL1318185	-	100
200	PN1318200	PL1318200	-	100
240	PN1318240	PL1318240	-	100
250	PN1318250	PL1318250	-	100
270	PN1318270	PL1318270	-	100
320	PN1318320	PL1318320	-	100
350	PN1318350	PL1318350	-	100
400	PN1318400	PL1318400	-	100
450	PN1318450	PL1318450	-	100
500	PN1318500	PL1318500	-	100
650	PN1318650	PL1318650	-	100
800	PN1318800	PL1318800	-	100
1000	PN13181000	PL13181000	-	100
460 x 570	-	-	HJ1318460570	100

Ref. 1303. Very fast filtration, crepe, thin

Size mm Ø	Plain	Folded	Sheets	units/box
25	PN1303025	-	-	100
42.5	PN13030425	-	-	100
47	PN1303047	-	-	100
50	PN1303050	-	-	100
55	PN1303055	-	-	100
70	PN1303070	PL1303070	-	100
90	PN1303090	PL1303090	-	100
110	PN1303110	PL1303110	-	100
125	PN1303125	PL1303125	-	100
130	PN1303130	PL1303130	-	100
150	PN1303150	PL1303150	-	100
185	PN1303185	PL1303185	-	100
200	PN1303200	PL1303200	-	100
240	PN1303240	PL1303240	-	100
250	PN1303250	PL1303250	-	100
270	PN1303270	PL1303270	-	100
320	PN1303320	PL1303320	-	100
350	PN1303350	PL1303350	-	100
400	PN1303400	PL1303400	-	100
450	PN1303450	PL1303450	-	100
500	PN1303500	PL1303500	-	100
650	PN1303650	PL1303650	-	100
800	PN1303800	PL1303800	-	100
1000	PN13031000	PL13031000	-	100
460 x 570	-	-	HJ1303460570	100

INFORMATION FOR ORDERS. General use qualitative analysis filter paper

Ref. 1300G. Mediu-fast filtration, smooth

Size mm Ø	Plain	Folded	Sheets	units/box
25	PN1300G025	-	-	100
42.5	PN1300G0425	-	-	100
47	PN1300G047	-	-	100
50	PN1300G050	-	-	100
55	PN1300G055	-	-	100
70	PN1300G070	PL1300G070	-	100
90	PN1300G090	PL1300G090	-	100
110	PN1300G110	PL1300G110	-	100
125	PN1300G125	PL1300G125	-	100
130	PN1300G130	PL1300G130	-	100
150	PN1300G150	PL1300G150	-	100
185	PN1300G185	PL1300G185	-	100
200	PN1300G200	PL1300G200	-	100
240	PN1300G240	PL1300G240	-	100
250	PN1300G250	PL1300G250	-	100
270	PN1300G270	PL1300G270	-	100
320	PN1300G320	PL1300G320	-	100
350	PN1300G350	PL1300G350	-	100
400	PN1300G400	PL1300G400	-	100
450	PN1300G450	PL1300G450	-	100
500	PN1300G500	PL1300G500	-	100
650	PN1300G650	PL1300G650	-	100
800	PN1300G800	PL1300G800	-	100
1000	PN1300G1000	PL1300G1000	-	100
460 x 570	-	-	HJ1300G460570	100

Ref. 1326. Fast filtration, crepe

Size mm Ø	Plain	Folded	Sheets	units/box
25	PN1326025	-	-	100
42.5	PN13260425	-	-	100
47	PN1326047	-	-	100
50	PN1326050	-	-	100
55	PN1326055	-	-	100
70	PN1326070	PL1326070	-	100
90	PN1326090	PL1326090	-	100
110	PN1326110	PL1326110	-	100
125	PN1326125	PL1326125	-	100
130	PN1326130	PL1326130	-	100
150	PN1326150	PL1326150	-	100
185	PN1326185	PL1326185	-	100
200	PN1326200	PL1326200	-	100
240	PN1326240	PL1326240	-	100
250	PN1326250	PL1326250	-	100
270	PN1326270	PL1326270	-	100
320	PN1326320	PL1326320	-	100
350	PN1326350	PL1326350	-	100
400	PN1326400	PL1326400	-	100
450	PN1326450	PL1326450	-	100
500	PN1326500	PL1326500	-	100
650	PN1326650	PL1326650	-	100
800	PN1326800	PL1326800	-	100
1000	PN13261000	PL13261000	-	100
460 x 570	-	-	HJ1325460570	100

Analytical grade qualitative filter paper

Recommended on qualitative analysis with high level precision



Description

FILTER-LAB® filter paper for qualitative analytic grade analyses are manufactured with cotton linters and cellulose fibers with a high purity. For that reason, is used on qualitative tests of elevated precision like the determination or the identification of the materials, for example.

These papers have excellent chemical and moisture resistance due to the addition, during the manufacturing process, an inert binder. This product contains nitrogen, which in the case of Kjeldall analysis, we recommend using filter paper FILTER-LAB® ref. 1290, low in N.

The range is formed by 7 qualities and are available in plain format, folded and sheets.

Technical specifications

Ref.	Filtration	Grammage	Thickness	Pore	Ashes
		g/m ²	mm	µm	%
1248	Very fast	80	0.210	25-30	< 0.1
1249	Fast	88	0.180	20-25	< 0.1
1250	Medium	87	0.180	10-15	< 0.1
1252	Medium-slow	80	0.160	7-9	< 0.1
1254	Slow	80	0.160	2-4	< 0.1
1256	Very slow	100	0.190	1-3	< 0.1
1258	Mediu-slow, thick	200	0.360	5-7	< 0.1

APPLICATIONS

Ref. 1248. Very fast filtration

- Filtration of samples with coarse precipitates.
- Filtration of musts.
- Food analysis.
- Determination of impurities in the iron and steel.

Ref. 1249. Fast filtration

- Filtration of thick precipitates as silver sulfurs, arsenic, cadmium, antimony, lead and cadmium alkaline carbonate.
- Determination of fat content.
- Soil Analysis

Ref. 1250. Medium filtration

- Analysis of beer and malt according to the parameters recommended by the EBC (European Brewery Convention)
- Filtration media samples precipitated as calcium oxalate or some metal sulfides
- Analysis fertilizers.
- Filtration hydrocarbon samples
- Analysis of black smoke into the atmosphere

Ref. 1252. Medium slow filtration

- Retention of fine precipitates as barium sulfate hot tin sulfide, nickel or zinc.
- Separation of particles in the food industry.
- Cauldron water testing

Ref. 1254. Slow filtration

- Degassing and analysis of beverage samples turbidity.
- Sample preparation prior to membrane filtration or spectrophotometry refractometry
- Filtration of very fine precipitates as barium sulfate or zinc sulfate cold

Ref. 1256. Very slow filtration

- Filtration of samples with very fine precipitates.
- Fine filtration of wine samples
- Water analysis

Ref. 1258. Medium-slow filtration, thick.

- Transport of biological samples
- Separation of elements by electrophoresis
- Determination of sulfur and sulphate in aggregates.
- Filtration of samples precipitated with high load
- Determination of some properties of aggregates

Formats and dimensions



25	42,5	47	50	55	70	90	110	125	150	185	200	240	250	270	300	320
----	------	----	----	----	----	----	-----	-----	-----	-----	-----	-----	-----	-----	-----	-----

Dimensions: Diameter in mm
Presentation: Packs of 100 units



70	90	110	125	150	185	200	240	250	270	300	320
----	----	-----	-----	-----	-----	-----	-----	-----	-----	-----	-----

Dimensions: Diameter in mm
Presentation: Packs of 100 units



460 x 570

Dimensions: Measures in mm
Presentation: Pack of 100 units

Other formats and dimensions available under demand

INFORMATION FOR ORDERS. Analytic grade qualitative filter paper
Ref. 1248. Very fast filtration

Size mm Ø	Plain	Folded	Sheets	units/box
25	PN1248025	-	-	100
47	PN1248047	-	-	100
50	PN1248050	-	-	100
55	PN1248055	-	-	100
70	PN1248070	PL1248070	-	100
90	PN1248090	PL1248090	-	100
110	PN1248110	PL1248110	-	100
125	PN1248125	PL1248125	-	100
150	PN1248150	PL1248150	-	100
185	PN1248185	PL1248185	-	100
200	PN1248200	PL1248200	-	100
240	PN1248240	PL1248240	-	100
250	PN1248250	PL1248250	-	100
270	PN1248270	PL1248270	-	100
300	PN1248300	PL1248300	-	100
320	PN1248320	PL1248320	-	100
203 x 254	-	-	HJ1248203254	100
460 x 570	-	-	HJ1248460570	100

Ref. 1249. Fast filtration

Size mm Ø	Plain	Folded	Sheets	units/box
25	PN1249025	-	-	100
47	PN1249047	-	-	100
50	PN1249050	-	-	100
55	PN1249055	-	-	100
70	PN1249070	PL1249070	-	100
90	PN1249090	PL1249090	-	100
110	PN1249110	PL1249110	-	100
125	PN1249125	PL1249125	-	100
150	PN1249150	PL1249150	-	100
185	PN1249185	PL1249185	-	100
200	PN1249200	PL1249200	-	100
240	PN1249240	PL1249240	-	100
250	PN1249250	PL1249250	-	100
270	PN1249270	PL1249270	-	100
300	PN1249300	PL1249300	-	100
320	PN1249320	PL1249320	-	100
203 x 254	-	-	HJ1249203254	100
460 x 570	-	-	HJ1249460570	100

Ref. 1250. Medium filtration

Size mm Ø	Plain	Folded	Sheets	units/box
25	PN1250025	-	-	100
47	PN1250047	-	-	100
50	PN1250050	-	-	100
55	PN1250055	-	-	100
70	PN1250070	PL1250070	-	100
90	PN1250090	PL1250090	-	100
110	PN1250110	PL1250110	-	100
125	PN1250125	PL1250125	-	100
150	PN1250150	PL1250150	-	100
185	PN1250185	PL1250185	-	100
200	PN1250200	PL1250200	-	100
240	PN1250240	PL1250240	-	100
250	PN1250250	PL1250250	-	100
270	PN1250270	PL1250270	-	100
300	PN1250300	PL1250300	-	100
320	PN1250320	PL1250320	-	100
203 x 254	-	-	HJ1250203254	100
460 x 570	-	-	HJ1250460570	100

Ref. 1252. Medium-slow filtration

Size mm Ø	Plain	Folded	Sheets	units/box
25	PN1252025	-	-	100
47	PN1252047	-	-	100
50	PN1252050	-	-	100
55	PN1252055	-	-	100
70	PN1252070	PL1252070	-	100
90	PN1252090	PL1252090	-	100
110	PN1252110	PL1252110	-	100
125	PN1252125	PL1252125	-	100
150	PN1252150	PL1252150	-	100
185	PN1252185	PL1252185	-	100
200	PN1252200	PL1252200	-	100
240	PN1252240	PL1252240	-	100
250	PN1252250	PL1252250	-	100
270	PN1252270	PL1252270	-	100
300	PN1252300	PL1252300	-	100
320	PN1252320	PL1252320	-	100
203 x 254	-	-	HJ1252203254	100
460 x 570	-	-	HJ1252460570	100

INFORMATION FOR ORDERS. Analytic grade qualitative filter paper

Ref. 1254. Slow filtration

Size mm Ø	Plain	Folded	Sheets	units/box
25	PN1254025	-	-	100
47	PN1254047	-	-	100
50	PN1254050	-	-	100
55	PN1254055	-	-	100
70	PN1254070	PL1254070	-	100
90	PN1254090	PL1254090	-	100
110	PN1254110	PL1254110	-	100
125	PN1254125	PL1254125	-	100
150	PN1254150	PL1254150	-	100
185	PN1254185	PL1254185	-	100
200	PN1254200	PL1254200	-	100
240	PN1254240	PL1254240	-	100
250	PN1254250	PL1254250	-	100
270	PN1254270	PL1254270	-	100
300	PN1254300	PL1254300	-	100
320	PN1254320	PL1254320	-	100
203 x 254	-	-	HJ1254203254	100
460 x 570	-	-	HJ1254460570	100

Ref. 1256. Very slow filtration

Size mm Ø	Plain	Folded	Sheets	units/box
25	PN1256025	-	-	100
47	PN1256047	-	-	100
50	PN1256050	-	-	100
55	PN1256055	-	-	100
70	PN1256070	PL1256070	-	100
90	PN1256090	PL1256090	-	100
110	PN1256110	PL1256110	-	100
125	PN1256125	PL1256125	-	100
150	PN1256150	PL1256150	-	100
185	PN1256185	PL1256185	-	100
200	PN1256200	PL1256200	-	100
240	PN1256240	PL1256240	-	100
250	PN1256250	PL1256250	-	100
270	PN1256270	PL1256270	-	100
300	PN1256300	PL1256300	-	100
320	PN1256320	PL1256320	-	100
203 x 254	-	-	HJ1256203254	100
460 x 570	-	-	HJ1256460570	100

Ref. 1258. Mediu-slow filtration, thick

Size mm Ø	Plain	Folded	Sheets	units/box
25	PN1258025	-	-	100
47	PN1258047	-	-	100
50	PN1258050	-	-	100
55	PN1258055	-	-	100
70	PN1258070	-	-	100
90	PN1258090	-	-	100
110	PN1258110	-	-	100
125	PN1258125	-	-	100
150	PN1258150	-	-	100
185	PN1258185	-	-	100
200	PN1258200	-	-	100
240	PN1258240	-	-	100
250	PN1258250	-	-	100
270	PN1258270	-	-	100
300	PN1258300	-	-	100
320	PN1258320	-	-	100
460 x 570	-	-	HJ1258460570	100

Technical filter paper for special analysis

Used in certain tests and processes for their special characteristics



Description

FILTER-LAB® makes available some technical filter paper grades for laboratory analysts which by their characteristics are adequate to perform certain tests in foods and raw materials fabrication with international normatives.

Technical specifications

Ref.	Filter type	Grammage	Thickness
		g/m ²	mm
1055	Technical filter paper	100	0.240
1301/190	Technical filter paper	185	0.410
1512	Technical filter paper	73	0.130
NW130L	Nonwoven filter	130	0.190
1301/450	Technical filter paper	450	0.990
S-600	Drying paper	600	1.500

INFORMATION FOR ORDERS. Technical filter paper for special analysis

Paper ref.	Product ref.	Description	Presentation
1055	PN1055185	Technical filter paper ref. 1055 185 mm	100 units/box
1055	PN1055200	Technical filter paper ref. 1055 200 mm	100 units/box
1055	PN1055240	Technical filter paper ref. 1055 240 mm	100 units/box
1301/190	HJ1301190/150-175	Technical filter paper ref. 1301/190 150 x 175 mm	100 units/pack
1512	PN1512070	Technical filter paper ref. 1512 70 mm	100 units/box
NW130L	PNNW130L032	Nonwoven filters ref. NW25L 32 mm	1.000 units/box
1301/450	PN1301450/25	Technical filter paper ref. 1301/450 25 mm	1.000 units/box

Other formats and dimensions available under demand

APPLICATIONS

Technical filter paper ref. 1055.

- Preparation and cleaning of wine mash samples

Technical filter paper ref. 1301/190

- Determination of the coefficient of absorption of water by capillarity of the hardened mortar according to the norm EN 1015-18

Qualitative analysis filter paper ref. 1512

- Determination of the performance of oil olive in automatic analyzer

Nonwoven filter ref. NW130L

- Determination of impurity content in raw milk and dairy products according to norm GB 5413.30

Technical filter paper ref. 1301/450

- Determination of the lacquered surfaces of furniture resistance to cold liquids through potentiometry according to norm UNE 89401

Absorbent carton ref. S-600

- Determination of the retention power of water of the pasta mortar according to norm ISO 5269-1: 1998

Double lay hand dryer paper

An enormous variety of applications in laboratories



Description

FILTER-LAB® double lay hand dryer paper is an indispensable paper in any laboratory because of its enormous applications.

It is provided in reels of 23 cm width and 500 longitudinal meters.

This reel can be provided with the roll holder ref. DP50, also available.

APPLICATIONS

Double lay hand dryer paper

- Surfaces cleaning
- Personal hygiene.
- Spillover absorption
- Fast drying of glass pieces, metallic, pieces, etc

Formats and dimensions



23 x 500

Dimensions: Width in cm x length in meters.
Presentation: Carton of 2 rolls.

INFORMATION FOR ORDERS. Double lay hand dryer paper and roll holder

Format	Dimensions (cm)	Code	Presentation
Paper reel	23 cm x 500 meters	BBSC230500	2 reels pack
Reel holder foot	Maximum width 50 cm	DP50	Unit
Reel holder wall	Maximum width 50 cm	WDP50	Unit

Dispenser for absorbent paper with polyethylene

Sheet cut at the same measure of the table or work surface



Description

Metallic dispenser for table adapted to reels with a width of 70 cm. Clean and fast cut.

INFORMATION FOR ORDERS

Absorbent paper in reels dispenser ref. DP70

Maximum width	Code
70 cm	DP70

Filter paper in reams

Protection and absorption of laboratory tables against splatters of liquids



Description

This is a range of paper made specially for the absorption of liquids and splatter and as protector in laboratory furniture, work tables, trays or instruments. Also used in the handling of sterile utensils, conditioning of pharmaceutical products, etc.

The range is formed by three qualities with different weights in grams and thickness

Technical specifications

Ref.	Grammage g/m ²	Thickness mm	Klemm's absorption* mm/10 min	Wet resistance* kN/m
1305	73	0.170	75/70	0.290/0.260
1510	60	0.130	60/55	0.280/0.230
1503	50	0.115	55/55	0.260/0.190

* Longitudinal sense/transversal sense

Formats and dimensions



32 x 42	42 x 52	50 x 50	52 x 52	58 x 58
---------	---------	---------	---------	---------

Dimensions: Measures in mm
Presentation: Packs of 500 sheets

Other formats and dimensions under demand.

INFORMATION FOR ORDERS. Filter paper in reams

Ref. 1305. Thick (73 g/m²)

Sizes (cm)	Code	Reams/carton
32 x 42	RM13053242	4
42 x 52	RM13054252	3
50 x 50	RM13055050	-
52 x 52	RM13055252	-
58 x 58	RM13055858	-

Ref. 1510. Medium (60 g/m²)

Sizes (cm)	Code	Reams/carton
32 x 42	RM15103242	5
42 x 52	RM15104252	3
50 x 50	RM15105050	-
52 x 52	RM15105252	-
58 x 58	RM15105858	-

Ref. 1503. Thin (50 g/m²)

Sizes (cm)	Code	Reams/carton
32 x 42	RM15033242	6
42 x 52	RM15034252	4
50 x 50	RM15035050	-
52 x 52	RM15035252	-
58 x 58	RM15035858	-

APPLICATIONS

Ref. 1305. Thick thickness (73 gr/m²)

- Protection of laboratory tables against splatters of liquids.
- Sporadic filtration of diverse liquids.
- Conditioning of chemical or pharmaceutical products.

Ref. 1510. Medium thickness (60 gr/m²)

- Protection of trays.
- Recuperation of solid value particles.

Ref. 1503. Thin thickness (50 gr/m²)

- Protection of trays and work tables.

Absorbent paper with polyethylene

Absorption and protection thanks to its double layer: one made of absorbent paper and other made of waterproof polyethylene



Description

The absorbent paper with polyethylene FILTER-LAB® has been created with the intention of achieving total protection in trays, laboratory tables, animal cages and in general any surface where complete watertightness is required.

It is formed by two faces. A face of blotting paper that allows excellent absorption of liquids and another face formed by a polyethylene film that guarantees absolute waterproof. Can be used by both faces. If the face with polyethylene is used, it allows the recovery of valuable materials or hazardous products.

Technical specifications

Ref.	Grammage	Thickness	Absorption in area
	g/m ²	mm	g water/m ²
1508	210	0.420	410
1505	125	0.250	240

Formats and dimensions



32 x 42	42 x 52	50 x 50	46 x 57
---------	---------	---------	---------

Dimensions: Measures in cm
Presentation: Packs of 100 and 500 units.



50 x 50	50 x 100
---------	----------

Dimensions: Width in cm x length in meters.
Presentation: Unitary

INFORMATION FOR ORDERS. Absorbent paper with polyethylene

Ref. 1508. Thick (210 g/m²)

Format	Dimensions (cm)	Code	Presentation
Sheets	32 x 42	HJ15083242	100 sheets
Sheets	42 x 52	HJ15084252	100 sheets
Sheets	46 x 57	HJ15084657	100 sheets
Sheets	50 x 50	HJ15085050	100 sheets
Sheets	32 x 42	RM15083242	500 sheets
Sheets	42 x 52	RM15084252	500 sheets
Sheets	46 x 57	RM15084657	500 sheets
Sheets	50 x 50	RM15085050	500 sheets
Reels	50 cm width x 50 meters	BB15085050	unit
Reels	50 cm width x 100 meters	BB150850100	unit

Ref. 1505. Thin (125 g/m²)

Format	Dimensions (cm)	Code	Presentation
Sheets	32 x 42	HJ15053242	100 sheets
Sheets	42 x 52	HJ15054252	100 sheets
Sheets	46 x 57	HJ15054657	100 sheets
Sheets	50 x 50	HJ15055050	100 sheets
Sheets	32 x 42	RM15053242	500 sheets
Sheets	42 x 52	RM15054252	500 sheets
Sheets	46 x 57	RM15054657	500 sheets
Sheets	50 x 50	RM15055050	500 sheets
Reels	50 cm width x 50 meters	BB15055050	unit
Reels	50 cm width x 100 meters	BB150550100	unit

APPLICATIONS

Absorbent paper with polyethylene

Ref. 1508. Thick (210 gr/m²)

Ref. 1505. Fine (125 gr/m²)

- Impermeable protection of laboratory miscellaneous.
- Saturation of the atmosphere of moist chambers.
- Recovery of valuable materials (precious metals, rare earths, etc.).
- Handling of toxic or hazardous liquids.
- Seed germination laboratories (method between papers or Viennese roll).
- Protection of soils in animal cages.
- Handling of chemical or pharmaceutical products.
- Anatomical pathology labs.
- Retention of excess tint in large plotters.

TRANSVERSAL CUT

Face of absorbent paper 100 or 190 gr/m²



Cara de polietileno: 20/25 g/m²



Waterproof effect on the face with polyethylene

Glass microfiber filters without binder

Recommended in analyses of air and water according to international standards



Descripción

Gama de filtros fabricados exclusivamente con microfibras de vidrio borosilicato al 100% y exentas de cualquier tipo de ligante.

Estos filtros son capaces de combinar rápidas velocidades de filtración con elevadas capacidades de carga junto a una excelente retención de partículas finas.

Especificaciones técnicas

Ref.	Retención μm	Gramaje g/m ²	Espesor mm	Retención DOP %	Ligante
MFV1	1.6	52	0.26	99.998	No
MFV2	1.0	143	0.70	99.998	No
MFV3	1.2	52	0.26	99.998	No
MFV4	2.7	120	0.53	99.998	No
MFV5	0.7	75	0.45	99.998	No
MFV6	1.5	65	0.28	99.998	No

PROPERTIES

Chemical stability

Glass microfiber filters from FILTER-LAB® have an excellent stability, being resistant to the majority of reagents and solvents, except acidic and base solutions of high concentration.

Thermal stability

Likewise, these filters can withstand operating temperatures up to 500°C. Beyond this approximate value it starts to lose its customary qualities. In case of operating temperatures of up to 900°C we recommend the use of FILTER-LAB® quartz microfiber filters, ref. MFQ.

Mechanical resistance

This kind of filters are resistant to creasing, so that's why the sheets can be folded for transport or sent to the laboratory for field atmospheric analyses, for example.

Permeability

Glass microfiber filters have high permeability against the passing of air so that is why they generally have good flow velocities. All of this make them ideal for the use in high-volume samplers.

APPLICATIONS

Ref. MFV1

- Control of immissions into the atmosphere through high volume samplers.
- Determination of suspended solids in water according to EN 872 and Standard Methods 2540D, as well as other analyzes of water pollution
- Quantitative determination of certain types of algae and bacteria cultures.
- Biochemical investigations.
- Determination of the presence of ozone in the air.
- Leaks review solvents.
- Food analysis.

Ref. MFV2

- Pre-filtration of samples before membrane filtration.
- Clarification instrumental samples before analysis.
- Biochemical assays

Ref. MFV3

- Determination of suspended solids in water according to EN872 and Standard Methods 2540D, as well as other analyzes of water pollution.
- Carbohydrate Analysis by hydrolysis.
- Filtration solvents.
- Filtering cell cultures.
- Filtration of samples prior to scintillation counting.

Ref. MFV4

- Pre-filtration of samples to avoid clogging of the membrane.
- Samples with high load of fine precipitates.
- Biological solutions.
- Determination of pollutants in animal fats and vegetable, according LMBG.

Ref. MFV5

- Analysis organisms in marine waters.
- Filtration HPLC samples.
- Biochemical Assays
- Gravimetric analysis of paints and pigments.
- Biological fluids.
- Determination of the leaching potential of contaminants according to TCLP.
- Determination of paper color solidity and alimentary grade cartons according to EN-646

Ref. MFV6

- Recommended as Standard Methods 2540D for determining suspended solids, total and dissolved.
- Clarification of cell cultures.

Retention of particles

The physical and chemical qualities of the glass microfibers are such that these filters have an excellent level of retention of particles, not only on the surface, but also depth through mechanisms of electrostatic adsorption and other processes, resulting in some cases of smaller retentions than a micron.

Stability in weight

Since they are not hygroscopic, the glass microfiber filters do not exhibit significant variations in weight.

Load capacity

Due to its high apparent density (relation between weight in grams and thickness) and the nature of the fibers, these filters have a large load capacity.

Formats and dimensions



13	25	37	47	55	70	80	90	110	125	150
----	----	----	----	----	----	----	----	-----	-----	-----

Dimensions: Diameter in mm
Presentation: Packs of 100 units



203 x 254	460 x 570
-----------	-----------

Dimensions: Measure in mm.
Presentation: Packs of 100 units.

Other formats and dimensions available under demand.

Metal traces (ppm)

As	Cd	Cr	Cu	Fe	Mn	Ni	Pb
3	0.03	12	3	400	20	4	3

Sb	V	Zn
2	1	50

INFORMATION FOR ORDERS. Glass microfiber filters.

MFV1

Size mm Ø	Code	units/box
13	MFV1013	100
25	MFV1025	100
37	MFV1037	100
47	MFV1047	100
55	MFV1055	100
70	MFV1070	100
80	MFV1080	100
90	MFV1090	100
110	MFV1110	100
125	MFV1125	100
150	MFV1150	100
203 x 254	MFV1203254	100

MFV2

Size mm Ø	Code	units/box
13	MFV2013	100
25	MFV2025	100
37	MFV2037	100
47	MFV2047	100
55	MFV2055	100
70	MFV2070	100
90	MFV2090	100
110	MFV2110	100
125	MFV2125	100
150	MFV2150	100
460 x 570	MFV2460570	100

MFV3

Size mm Ø	Code	units/box
13	MFV3013	100
25	MFV3025	100
37	MFV3037	100
47	MFV3047	100
55	MFV3055	100
70	MFV3070	100
90	MFV3090	100
110	MFV3110	100
125	MFV3125	100
150	MFV3150	100
460 x 570	MFV3460570	100

MFV4

Size mm Ø	Code	units/box
13	MFV4013	100
25	MFV4025	100
37	MFV4037	100
47	MFV4047	100
55	MFV4055	100
70	MFV4070	100
90	MFV4090	100
110	MFV4110	100
125	MFV4125	100
150	MFV4150	100
460 x 570	MFV4460570	100

MFV5

Size mm Ø	Code	units/box
13	MFV5013	100
25	MFV5025	100
37	MFV5037	100
47	MFV5047	100
55	MFV5055	100
70	MFV5070	100
90	MFV5090	100
110	MFV5110	100
125	MFV5125	100
150	MFV5150	100
460 x 570	MFV5460570	100

MFV6

Size mm Ø	Code	units/box
13	MFV6013	100
25	MFV6025	100
37	MFV6037	100
47	MFV6047	100
55	MFV6055	100
70	MFV6070	100
90	MFV6090	100
110	MFV6110	100
125	MFV6125	100
150	MFV6150	100
460 x 570	MFV6460570	100

Glass microfiber filters with binders

Recommended on atmospheric and water analyses. Pre-filtration of samples



Description

The glass microfiber filters with binders are made with glass microfiber with binders of organic type.

Due to their high velocity liquid flow and high air permeability is recommended for analysis atmospheric air filtration equipment of combustion analysis, control and purification of industrial compartments, pre-filtration before membranes, etc.

Their chemical stability is very high and when a depth filter, retaining their ability to fine particles is very important.

Technical specifications

Ref.	Retention μm	Grammage g/m ²	Thickness mm	Filtration DIN 53137 s	Max. Temp. °C	Binder
MFVL7	0.6	70	0.35	15	200	organic
MFVL8	0.5	90	0.4	22	200	organic
13400	0.7	70	0.55	-	220	organic

Formats and dimensions



25	37	47	55	70	90	110	125	150
----	----	----	----	----	----	-----	-----	-----

Dimensions: Diameter in mm

Presentation: Packs of 100 units, except for 13400

INFORMATION FOR ORDERS. Glass microfibre filters with binders

MFVL7

Size mm Ø	Code	units/box
25	MFVL7025	100
37	MFVL7037	100
47	MFVL7047	100
55	MFVL7055	100
70	MFVL7070	100
90	MFVL7090	100
110	MFVL7110	100
125	MFVL7125	100
150	MFVL7150	100

MFVL8

Size mm Ø	Code	units/box
25	MFVL8025	100
37	MFVL8037	100
47	MFVL8047	100
55	MFVL8055	100
70	MFVL8070	100
90	MFVL8090	100
110	MFVL8110	100
125	MFVL8125	100
150	MFVL8150	100

13400

Size mm Ø	Code	units/box
13	13400-013S	200
42	13400-042Q	500
47	13400-047Q	500
50	13400-050Q	500
100	13400-100K	50
142	13400-142K	50
293	13400-293K	50

APPLICATIONS

Ref. MFVL7

- Pre-filtration of samples before the filtration in the membrane.
- Atmospherically measuring cubicles.
- Measuring of combustion equipments.

Ref. MFVL8

- Analyses of combustion air.
- Pre-filtration of samples.

Ref. 13400

- Water analyses.
- Pre-filtration of samples.

Quartz microfiber filters ref. MFQ and MFQ360

Atmospheric controls of emission, immission and studies of metals in the air

Filters made exclusively with pure quartz (Si O₂) microfibers, free from any type of bonding agent or other substances. Subsequently treated thermally to achieve very low levels of heavy metals.

Specially recommended in controls of emission in industrial smokestacks, specially when a very pure filter is required or when the physical or chemical conditions of the gases are extreme: temperature higher than 500°C or stronger acid concentration (except HF).

It made two qualities, one standard and one more pure, heat-treated for minimal metal content.

Technical specifications

Ref.	Grammage	Thickness	DOP retention	Max. Temp.	Binder
	g/m ²	mm	% a 0.3 μm	°C	
MFQ	85	0.38	99.998	900	No
MFQ360	85	0.45	99.998	900	No

Chemical stability: It has an excellent chemical stability against acidic gases such as SO₂, HCl, SO₃, SO₄, NO, NO₃, except HF. With hardly any loss of mass of the filter through possible chemical reactions.

Thermal stability: It is resistant to operating temperatures up to 900°C.

Permeability: Excellent behavior during the passing of significant volumes of gases, which makes it ideal for the use in high-volume detectors.

Retention of particles: The structure and the physical and chemical properties of quartz microfibers are such that these filters have a high level of retention of particles not only on the surface but also in the internal structure of the frame.

Formats and dimensions



25	37	47	55	70	90	110	125	150
----	----	----	----	----	----	-----	-----	-----

Dimensions: Diameter in mm
Presentation: Packs of 25 units.



203 x 254

Dimensions: Measures in mm.
Presentation: Packs of 25 units.

INFORMATION FOR ORDERS. Quartz microfiber filters

MFQ

Size mm Ø	Code	units/box
25	MFQ025	25
37	MFQ037	25
47	MFQ047	25
55	MFQ055	25
70	MFQ070	25
90	MFQ090	25
110	MFQ110	25
125	MFQ125	25
150	MFQ150	25
203 x 254	MFQ203254	25

MFQ360

Size mm Ø	Code	units/box
25	MFQ360025	25
37	MFQ360037	25
47	MFQ360047	25
55	MFQ360055	25
70	MFQ360070	25
90	MFQ360090	25
110	MFQ360110	25
125	MFQ360125	25
150	MFQ360150	25
203 x 254	MFQ360203254	25

APPLICATIONS

Ref. MFQ (standard quality)

- Control of emissions in industrial chimneys.
- Control of immissions in high volume detectors.
- Gravimetric determinations on gases.
- Isokinetic probes.

Metal traces ref. MFQ (mg/kg)

Al	As	Cd	Co	Cr	Cu	Fe	Hg
50	0.75	1.5	1	5	1.25	30	<0.05

Mg	Mn	Na	Ni	Pb	Sb	Sn	Ti
1.25	25	40	2	0.75	1.25	0.5	2.5

V	Zn
0.5	5

Ref. MFQ360 (thermal treatment)

- Studies of content of heavy metals in the atmosphere.
- Quantification of presence of aromatic polycyclic hydrocarbons in the air.

Metal traces ref. MFQ360 (mg/kg)

Al	As	Cd	Co	Cr	Cu	Fe	Hg
25	0.2	0.02	0.5	3.5	<1	20	<0.025

Mg	Mn	Na	Ni	Pb	Sb	Sn	Ti
1	50	10	0.5	0.3	<1	<0.5	1.5

V	Zn
<0.5	3

Diatomaceous filter paper ref. 1297

Filtration of samples with semi-colloidal particles

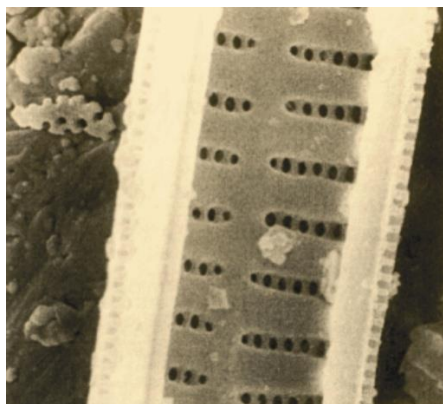

APPLICATIONS

Ref. 1297

- Filtration of samples for analyses by spectrophotometry.
- Filtration of clay samples.
- Division of samples with oxides of Cu.
- Filtration of protein samples.

Description

Filter paper with slow speed filtration. Manufactured with a mixture of cellulose fibers and diatomaceous soil (diatomaceous algae), whose main property is its microspores structure, with pores of up to 0.5µm.

The production process of the diatomaceous earth starts with extraction in an open pit. Later a drying phase is initiated and it is subjected to high temperatures to eliminated any organic remaining and inorganic residue. Finally it is crushed for use in industry.

This filter paper has the advantage of combining excellent retention of very fine or semi colloidal particles with a velocity of filtration quicker than that of any cellulose filter paper of slow filtration.

Technical specifications

Ref.	Filtration	Grammage	Thickness
		g/m ²	mm
1297	Slow	140	0.320

Formats and dimensions

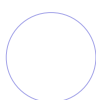

90	110	125	150	185	240	270	400	500
----	-----	-----	-----	-----	-----	-----	-----	-----

Dimensions: diameter in mm
Presentation: packsof 100 units

Other formats and dimensions available under demand.

INFORMATION FOR ORDERS. Diatomaceous filter paper with ref. 1297

Size mm ø	Code	units/box
90	PN1297090	100
110	PN1297110	100
125	PN1297125	100
150	PN1297150	100
185	PN1297185	100
240	PN1297240	100
270	PN1297270	100
400	PN1297400	100
500	PN1297500	100

Phase separator paper ref. 1291

Phase separation in mixed samples (organic and aqueous)



APPLICATIONS

Ref. 1291

- Separation of phases in mixed aqueous-organic samples.
- Filtration of solvents for extraction.
- Separator of emulsions.

Description

This is a paper with a medium velocity of filtration and made with linters of cotton and noble cellulose soaked in a type of stabilized hydrophobic silicone that allows the separation of mixed samples, that is, formed by an aqueous phase and an organic phase. This makes sure that the aqueous phase is maintained in the funnel while the organic phase passes through the filter.

So, in many applications, the phase separator paper can replace the separation funnels.

Its use is specially indicated in the separation of samples of aqueous phases and petroleum, ether, chloroform, oils, filtration of solvents for extraction, separation of emulsions, etc.

Technical specifications

Ref.	Filtration	Grammage	Thickness
		g/m ²	mm
1291	Medium	85	0.173

Formats and dimensions



70	90	110	125	150	185	200	240	270
----	----	-----	-----	-----	-----	-----	-----	-----

Dimensions: diameter in mm
Presentation: packs of 100 units



70	90	110	125	150	185	200	240	270
----	----	-----	-----	-----	-----	-----	-----	-----

Dimensions: diameter in mm
Presentation: packs of 100 units

Other formats and dimensions available under demand.

INFORMATION FOR ORDERS. Phase separator paper ref. 1291

Size mm Ø	plain	folded	units/box
70	PN1291070	PL1291070	100
90	PN1291090	PL1291090	100
110	PN1291110	PL1291110	100
125	PN1291125	PL1291125	100
150	PN1291150	PL1291150	100
185	PN1291185	PL1291185	100
200	PN1291200	PL1291200	100
240	PN1291240	PL1291240	100
270	PN1291270	PL1291270	100

Paper free of P and K, low in N ref. 1290

Analyses of soils and minerals



APPLICATIONS

Ref. 1290

- Determination of phosphates and nitrates in samples of soils by Ehmer, Riehm and Lederle.
- Analysis nitrogen components in beer samples.
- Filtration of samples prior to digestion by the Kjeldahl method.
- Quality analysis in mining.

Description

A filter paper with medium velocity of filtration and free from phosphates, potassium and with low nitrogen content. Is used most of all in the analysis of soils, determination of phosphates or nitrates, analysis of the component of nitrogen in beers and other controls.

Technical specifications

Ref.	Filtration	Grammage	Pore size
		g/m ²	µm
1290	Medium	80	15-17

Formats and dimensions



90	110	125	150	185	200	240	270	320
----	-----	-----	-----	-----	-----	-----	-----	-----

Dimensions: Diameter in mm
Presentation: Packs of 100 units



90	110	125	150	185	200	240	270	320
----	-----	-----	-----	-----	-----	-----	-----	-----

Dimensions: Diameter in mm
Presentation: Packs of 100 units

Other formats and dimensions available under demand.

INFORMATION FOR ORDERS. Filter paper free of P and K, low N content ref. 1290

Size mm Ø	plain	folded	units/box
90	PN1290090	PL1290090	100
110	PN1290110	PL1290110	100
125	PN1290125	PL1290125	100
150	PN1290150	PL1290150	100
185	PN1290185	PL1290185	100
200	PN1290200	PL1290200	100
240	PN1290240	PL1290240	100
270	PN1290270	PL1290270	100
320	PN1290320	PL1290320	100

Active carbon filter paper ref. 1284

Discoloration of samples and attraction of radioactive ions



Description

FILTER-LAB® filter paper with active carbon was developed based on a mixture of noble cellulose and active carbon. Is a paper with slow velocity of filtration. It is specially indicated for the filtration of turbid samples such as those of urine for the determination of sugar. Is also used for capturing radioactive ions in atmospheres close to nuclear power stations.

Technical specifications

Ref.	Filtration	Grammage
		g/m^2
1284	Slow	155

APPLICATIONS

- Determination of the sugar content in urine by polarimetric methods.
- Determination of the presence of radioactive ions in the atmosphere.
- Color removal of turbid samples.
- Filtration of galvanizing baths.

Formats and dimensions



90	110	125	150	185	240
----	-----	-----	-----	-----	-----

Dimensions: Diameter in mm
Presentation: Packs of 100 units

Other formats and dimensions available under demand.

INFORMATION FOR ORDERS

Active carbon filter paper ref. 1284

Size mm \varnothing	Code	units/box
90	PN1284090	100
110	PN1284110	100
125	PN1284125	100
150	PN1284150	100
185	PN1284185	100
240	PN1284240	100

Black filter paper ref. 1457

Display, by contrast, of white particles



Description

A black dyed filter paper, specially intended for the retention and posterior display of light color by contrast. For example, with some fluor or silicone compounds.

Formats and dimensions



55	70	90	110	125	150	185	200
----	----	----	-----	-----	-----	-----	-----

Dimensions: Diameter in mm
Presentation: Packs of 100 units

Other formats and dimensions available under demand.

Technical specifications

Ref.	Filtration	Grammage	Thickness
		g/m^2	mm
1457	Medium	155	0.17

APPLICATIONS

- Lump content determination in industrial and alimentary products.
- Display, by contrast, of light colored particles.
- Solid particles recount in milk samples

INFORMATION FOR ORDERS

Black filter paper ref. 1457

Size mm \varnothing	plain	units/box
55	PN1457055	100
70	PN1457070	100
90	PN1457090	100
110	PN1457110	100
125	PN1457125	100
150	PN1457150	100
185	PN1457185	100
200	PN1457200	100

Filter paper for analyses of fats ref. 1299

Especially for critical analyses of fats



Description

This filter is especially manufactured for the analysis of fats. A special treatment with organic solvents ensures practically zero fat content and resins (ether soluble residue <0.1 mg for a 270 mm filter diameter).

Technical specifications

Ref.	Grammage	Thickness	DIN filtration 53137
	g/m ²	mm	s
1299	70	0.16	22

Formats and dimensions



47	50	55	70	90	110	125	150	185	200	240	270	320
----	----	----	----	----	-----	-----	-----	-----	-----	-----	-----	-----

Dimensiones: diámetro en mm
Presentación: Cajas de 100 unidades



70	90	110	125	150	185	200	240	270	320
----	----	-----	-----	-----	-----	-----	-----	-----	-----

Dimensions: Diameter in mm
Presentation: Packs of 100 units

Other formats and dimensions available under demand

INFORMATION FOR ORDERS. Fats analysis filter paper ref. 1299

Size mm Ø	plain	folded	units/box
47	PN1299047	-	100
50	PN1299050	-	100
55	PN1299055	-	100
70	PN1299070	PL1299070	100
90	PN1299090	PL1299090	100
110	PN1299110	PL1299110	100
125	PN1299125	PL1299125	100
150	PN1299150	PL1299150	100
185	PN1299185	PL1299185	100
200	PN1299200	PL1299200	100
240	PN1299240	PL1299240	100
270	PN1299270	PL1299270	100
320	PN1299320	PL1299320	100

APPLICATIONS

Ref. 1299

- Critical analyses of fat's content in all type of substances.

Non-woven fabric filters

Filtrations of high flow rates in special applications



Description

Non-woven fabric filters are made with very long synthetic fibers, combined with each other in a more or less regular fashion by synthetic resins. These filters exhibit some interesting properties when compared to other traditional types such as those made of cellulose:

- **High physical resistance:** thanks to the great length and the specific nature of the fibers, non-woven fabric filters have good physical resistance in both dry and moist form.
- **Allow the passing of large volumes:** its very low apparent density makes sure that the frequency of pores is very high, allowing the passing of significant volumes of fluid.
- **Bigger pore size:** filters with pore parameters between 30 and 250 μm .

Technical specifications

Ref.	Grammage g/m^2	Thickness mm	Traction resistance* kg/5 cm dry (DIN 53857)	Water flow $\text{m}^3/\text{m}^2/\text{hour}$	Average porosity l/dm ² /min (DIN 53887)
NW 25 L	25	0.190	3.60/1.05	125	1830
NW 35 L	35	0.240	5.20/1.50	100	1610
NW 65 L	65	0.390	8.70/2.50	70	902
NW 130 L	125	0.900	13.00/4.00	n.a.	n.a.

* Longitudinal sense/ transversal sense.

Formats and dimensions

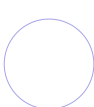

32*	47	50	55	70	90	110	125	150	200
-----	----	----	----	----	----	-----	-----	-----	-----

Dimensions: Diameter in mm

Presentation: Packs of 100 units., except 32 mm (pack of 1.000 units)

Other formats and dimensions available under demand

INFORMATION FOR ORDERS. Non woven filters

NW 25 L			NW 35 L			NW 65 L			NW 130 L		
mm \varnothing	Code	units/box	mm \varnothing	Code	units/box	mm \varnothing	Code	units/box	mm \varnothing	Code	units/box
47	PNNW25L047	100	47	PNNW35L047	100	47	PNNW65L047	100	32	PNNW130L032	1000
50	PNNW25L050	100	50	PNNW35L050	100	50	PNNW65L050	100	47	PNNW130L047	100
55	PNNW25L055	100	55	PNNW35L055	100	55	PNNW65L055	100	50	PNNW130L050	100
70	PNNW25L070	100	70	PNNW35L070	100	70	PNNW65L070	100	55	PNNW130L055	100
90	PNNW25L090	100	90	PNNW35L090	100	90	PNNW65L090	100	70	PNNW130L070	100
110	PNNW25L110	100	110	PNNW35L110	100	110	PNNW65L110	100	90	PNNW130L090	100
125	PNNW25L125	100	125	PNNW35L125	100	125	PNNW65L125	100	110	PNNW130L110	100
150	PNNW25L150	100	150	PNNW35L150	100	150	PNNW65L150	100	125	PNNW130L125	100
200	PNNW25L200	100	200	PNNW35L200	100	200	PNNW65L200	100	150	PNNW130L150	100
									200	PNNW130L200	100

Stainless steel mesh filters

Particle retention and pre-filtration before being cellulose

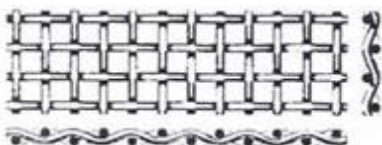

Description

A mesh of stainless steel is formed by a ensemble of wires tidily intertwined with each other and with the corresponding tension. Must meet a criteria indicated by the ISO 9044 standard, both with regard to its properties and tolerances as well as the system of inspection and verification of the metal fabric.

The parameters that identify a steel mesh filter are different from those of filter papers. The most important are:

Mesh opening (w): is the length of the bisector of the square that forms the mesh.

Diameter of wire (d): diameter of the wire before weaving..

Mesh (p): sum of the mesh opening (w) and the wire diameter (d).

Useful surface of sifted material (Fo): is the relation between the area of the openings and the total area of the mesh. $Fo = (w/p)^2 \times 100$, expressed in %

Weight: (G): for metallic materials of stainless steel, $G = 12.61 \times (d^2/p)$, expressed in kg/m².

Regarding the quality of the material, stainless steel type AISI 304 or 316.

The range is formed by filters with mesh opening from 20 to 900 µm.

APPLICATIONS

- Support for multiple filters.
- Pre-filtration of samples with big particles.
- Filtration of high volume samples.
- Division of cosmetically samples.
- Determination of caliber.
- Protection of security in industrial lines.
- Systems of retention of particles in cascade.

Technical specifications

Ref.	Mesh opening W (µm)	Ø wire d (mm)	Sieved surface Fo (%)	Weight kg/m ²
FM10	10	18	23.00	0.11
FM20	20	20	25.00	0.13
FM25	25	25	25.00	0.16
FM36	36	30	29.75	0.17
FM50	50	36	33.80	0.19
FM75	75	50	36.00	0.25
FM100	100	71	34.20	0.37
FM150	150	100	36.00	0.50
FM200	200	140	34.60	0.73
FM250	250	160	37.18	0.79
FM500	500	315	37.64	0.54
FM710	710	450	37.46	2.20
FM900	900	500	41.33	2.25

Formats and dimensions



47	55	70	90	110	125	150	200
----	----	----	----	-----	-----	-----	-----

Dimensions: Diameter in mm

Presentation: Packs of 100 units

Other formats and dimensions available under demand

INFORMATION FOR ORDERS. Stainless steel mesh filters

\varnothing (mm)	FM10	FM20	FM25	FM36	FM50	FM75	FM100	FM150	FM200
	10 μm	20 μm	25 μm	36 μm	50 μm	75 μm	100 μm	150 μm	200 μm
47	FM10047	FM20047	FM25047	FM36047	FM50047	FM75047	FM100047	FM150047	FM200047
55	FM10055	FM20055	FM25055	FM36055	FM50055	FM75055	FM100055	FM150055	FM200055
70	FM10070	FM20070	FM25070	FM36070	FM50070	FM75070	FM100070	FM150070	FM200070
90	FM10090	FM20090	FM25090	FM36090	FM50090	FM75090	FM100090	FM150090	FM200090
110	FM10110	FM20110	FM25110	FM36110	FM50110	FM75110	FM100110	FM150110	FM200110
125	FM10125	FM20125	FM25125	FM36125	FM50125	FM75125	FM100125	FM150125	FM200125
150	FM10150	FM20150	FM25150	FM36150	FM50150	FM75150	FM100150	FM150150	FM200150
200	FM10200	FM20200	FM25200	FM36200	FM50200	FM75200	FM100200	FM150200	FM200200

\varnothing (mm)	FM250	FM500	FM710	FM900
	250 μm	500 μm	710 μm	900 μm
47	FM250047	FM500047	FM710047	FM900047
55	FM250055	FM500055	FM710055	FM900055
70	FM250070	FM500070	FM710070	FM900070
90	FM250090	FM500090	FM710090	FM900090
110	FM250110	FM500110	FM710110	FM900110
125	FM250125	FM500125	FM710125	FM900125
150	FM250150	FM500150	FM710150	FM900150
200	FM250200	FM500200	FM710200	FM900200

Polyamide (nylon) mesh filters

Retention of particles and pre-filtration before cellulose filters

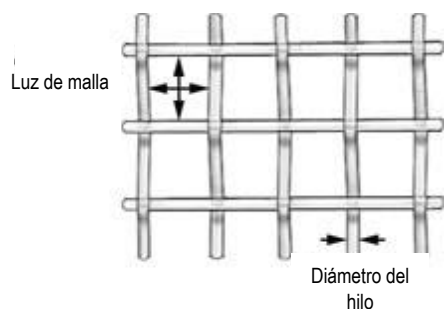

Description

This is a filter having a structure identical to filter stainless steel mesh. The only difference is the material: polyamide.

The parameters that identify a filter mesh of polyamide (nylon) are:

Aperture width (w): is the length in microns of the bisector of the square forming the mesh.

Wire diameter (d): Wire diameter before weaving.

Mesh (p): Sum of the mesh size (w) and wire diameter (d).

Nett sieving (Fo): The ratio between the area of the openings with respect to the total surface of the mesh. $Fo = (w / p)^2 \times 100$, expressed in%.

The range consists of filters with mesh sizes from 10-900 microns.

Technical specifications

Ref.	Mesh opening	Open area	Thickness
	W (µm)	%	(µm)
NY10	10	6	65
NY25	25	14	55
NY35	35	18	65
NY50	50	37	50
NY75	75	40	75
NY100	100	44	80
NY150	150	43	120
NY200	200	48	135
NY250	250	53	160
NY500	500	50	190
NY750	750	49	240
NY900	900	52	300

Formats and dimensions



47	55	70	90	110	125	150	200
----	----	----	----	-----	-----	-----	-----

Dimensions: Diameter in mm
Presentation: Packs of 100 units

Other formats and dimensions available under demand

APPLICATIONS

- Purification of drinking water
- Retention of solids in water
- Analyses of carbon's dust
- Clarification of serum
- Analyses of floors
- Pre-filtration of samples before a deep filter
- Cascade filtration systems for high volume samples
- Algae recollections and marine microorganisms
- Paint filtration
- Determination of particles size in abrasion polishing processes
- Security filtration in production lines

INFORMATION FOR ORDERS. Polyamide (nylon) mesh filters

\varnothing (mm)	NY10	NY25	NY35	NY50	NY75	NY100	NY150	NY200	NY250
	10 μm	25 μm	35 μm	50 μm	75 μm	100 μm	150 μm	200 μm	250 μm
47	NY10047	NY25047	NY35047	NY50047	NY75047	NY100047	NY150047	NY200047	NY250047
55	NY10055	NY25055	NY35055	NY50055	NY75055	NY100055	NY150055	NY200055	NY250055
70	NY10070	NY25070	NY35070	NY50070	NY75070	NY100070	NY150070	NY200070	NY250070
90	NY10090	NY25090	NY35090	NY50090	NY75090	NY100090	NY150090	NY200090	NY250090
110	NY10110	NY25110	NY35110	NY50110	NY75110	NY100110	NY150110	NY200110	NY250110
125	NY10125	NY25125	NY35125	NY50125	NY75125	NY100125	NY150125	NY200125	NY250125
150	NY10150	NY25150	NY35150	NY50150	NY75150	NY100150	NY150150	NY200150	NY250150
200	NY10200	NY25200	NY35200	NY50200	NY75200	NY100200	NY150200	NY200200	NY250200

\varnothing (mm)	NY500	NY750	NY900
	500 μm	750 μm	900 μm
47	NY500047	NY750047	NY900047
55	NY500055	NY750055	NY900055
70	NY500070	NY750070	NY900070
90	NY500090	NY750090	NY900090
110	NY500110	NY750110	NY900110
125	NY500125	NY750125	NY900125
150	NY500150	NY750150	NY900150
200	NY500200	NY750200	NY900200

Cellulose extraction thimbles

Separation of compose made of solid material in extractors



Description

FILTER-LAB® cellulose extraction thimbles are made of fibre of noble cellulose and linters of cotton that are completely free from impurities.

Frequently used in Soxhlet, Tecator or similar type extractors. Located in the inside of the extractor body, use to accommodate a sample solid material from which component must be separated by the addition of sufficient solvent.

Sometimes, it is necessary to get a more precise filtration or even have a more resistant thimble to some solvent. Likewise, two qualities are manufactured by the thimble's wall thickness:

Ref. 1800. Standard thickness: 1-2 mm. Medium filtration.

Ref. 1880. Double thickness: 2-4 mm. Medium-slow filtration.

Thimble's dimensions, standard thickness ref.1800



10 x 50	16 x 100	19 x 90	20 x 45	22 x 50	22 x 60	22 x 80	22 x 100	24 x 110	25 x 65	25 x 70	25 x 80	25 x 100
26 x 60*	27 x 80	27 x 100	28 x 80	28 x 100	30 x 60	30 x 77	30 x 80	30 x 100	33 x 80	33 x 94	33 x 100	33 x 118
35 x 50	35 x 60	35 x 80	35 x 100	35 x 110	35 x 150	40 x 100	40 x 123	43 x 123	48 x 145	50 x 160	53 x 145	60 x 120
68 x 250	75 x 160	90 x 180	90 x 210									

Wall's thickness: Between 1 and 2 mm
 Dimensions: Inner diameter x length in mm
 Presentation: Packs of 25 units

* Special dimension Tecator: Inner diameter x length in mmm

Double Thick Thimble's dimensions ref.1880



19 x 90	22 x 80	25 x 100	28 x 100	30 x 100	33 x 80	33 x 94	33 x 100	35 x 100	60 x 120	68 x 250	75 x 160	90 x 180
---------	---------	----------	----------	----------	---------	---------	----------	----------	----------	----------	----------	----------

Wall's thickness: Between 2 and 4 mm
 Dimensions: Inner diameter x length in mm
 Presentation: Packs of 25 units

APPLICATIONS

- Determination by extraction of the content of free lipids in food.
- Extraction of sulphur in gaseous masses.
- Extraction and quantification of components in industrial products: paint, animal fat, cosmetics, pavements, varnishes, lacquers, etc.
- Dimensions of dust in air or industrial gases.
- Determination of resin and fat in the wood and their derivatives.
- Determination of fat content in oilseeds



Correct selection of the dimensions of an extraction thimble for Soxhlet extractors.

- Length: placed with the mouth upwards, the thimble must stop at the upper part of the siphon opening.

- Inner diameter: the sum of the inner diameter of the thimble plus the thickness of the wall must be less by 2 or 3 mm than the corresponding inner diameter of the extractor body.

-In Tecator extractors or similar the measures are what every equipment demands.

INFORMATION FOR ORDERS. Cellulose extraction thimbles, standard thickness ref. 1800

Size mm Ø	Code	units/box
10 x 50	CC1050	25
16 x 100	CC16100	25
19 x 90	CC1990	25
20 x 45	CC2045	25
22 x 50	CC2250	25
22 x 60	CC2260	25
22 x 80	CC2280	25
22 x 100	CC22100	25
24 x 110	CC24110	25
25 x 65	CC2565	25
25 x 70	CC2570	25
25 x 80	CC2580	25
25 x 100	CC25100	25
26 x 60*	CC2660	25
27 x 80	CC2780	25
27 x 100	CC27100	25
28 x 80	CC2880	25
28 x 100	CC28100	25
30 x 60	CC3060	25
30 x 77	CC3077	25
30 x 80	CC3080	25
30 x 100	CC30100	25

Size mm Ø	Code	units/box
33 x 80	CC3380	25
33 x 94	CC3394	25
33 x 100	CC33100	25
33 x 118	CC33118	25
35 x 50	CC3550	25
35 x 60	CC3560	25
35 x 80	CC3580	25
35 x 100	CC35100	25
35 x 110	CC35110	25
35 x 150	CC35150	25
40 x 100	CC40100	25
40 x 123	CC40123	25
43 X 123	CC43123	25
48 x 145	CC48145	25
50 x 160	CC50160	25
53 x 145	CC53145	25
60 x 120	CC60120	25
68 x 250	CC68250	25
75 x 160	CC75160	25
90 x 180	CC90180	25
90 x 210	CC90210	25

INFORMATION FOR ORDERS. Cellulose extraction thimbles, double thick ref. 1880

Size mm Ø	Code	units/box
19 x 90	CCDG1990	25
22 x 80	CCDG2280	25
25 x 100	CCDG25100	25
28 x 100	CCDG28100	25
30 x 100	CCDG30100	25
33 x 80	CCDG3380	25
33 x 94	CCDG3394	25
33 x 100	CCDG33100	25
35 x 100	CCDG35100	25
60 x 120	CCDG60120	25
68 x 250	CCDG68250	25
75 x 160	CCDG75160	25
90 x 180	CCDG90180	25

Glass microfiber thimbles ref. 1900

Recommended on aerosols analysis, particles analysis and extraction analyses.



APPLICATIONS

- Control of emission in industrial smokestacks.
- Extractions with very aggressive solvents.
- Pre-filtration of gases in analyzers.
- Gravimetric analysis of dust in gases.

Metal traces (mg/Kg)

As	Cd	Cr	Cu	Fe	Mn	Ni	Pb
3	0.03	12	3	400	20	4	3

Sb	V	Zn
2	1	50

Description

In the same way that the glass microfiber filters, glass microfiber extraction thimbles FILTER-LAB® fibers are made from borosilicate 100% free of binders. Possess the same characteristics as the filters of this material, i.e. chemical stability, maximum operating temperature to 500 ° C, high air flow permeability, good retention capacity and particle weight and stability. This makes it very suitable for use in emission controls at high temperature gas analyzers pre-filtration, gravimetric analysis, etc.

In case that the analyzed gases having high acidic or alkaline concentration or the temperature exceeds 500 ° C then we advise the quartz microfiber extraction thimbles FILTER-LAB®.

Technical specifications

Ref.	Composition	Retention	DOP penetration	Max. Temperature	Binders
		% a 0.3 µm	% a 0.3 µm		
1900	100% glass microfiber	99.998	< 0.002	500°C	No

Glass microfiber filters' dimensions ref. 1900



10 x 50	19 x 90	22 x 80	26 x 60	26 x 80	30 x 80	30 x 100	33 x 80	33 x 94	35 x 150	43 x 123	53 x 145
---------	---------	---------	---------	---------	---------	----------	---------	---------	----------	----------	----------

Dimensions: Diameter inside x length in mm
Presentation: Packs of 25 units

INFORMATION FOR ORDERS. Glass microfiber filters ref. 1900

Ø int x lenght (mm)	Code	units/box
10 x 50	CB1050	25
19 x 90	CB1990	25
22 x 80	CB2280	25
26 x 60	CB2660	25
26 x 80	CB2680	25
30 x 80	CB3080	25
30 x 100	CB30100	25
33 x 80	CB3380	25
33 x 94	CB3394	25
35 x 150	CB35150	25
43 x 123	CB43123	25
53 x 145	CB53145	25

Quartz microfiber filters ref. CQ2000

Analysis of emission with aggressive gases or very high temperature



APPLICATIONS

- Control of emissions in industrial smokestacks with isokinetic probes or temperatures up to 900°C.
- Gravimetric calculations in gases.

Metal traces (mg/Kg)

Al	As	Cd	Co	Cr	Cu	Fe	Hg
50	0.75	1.5	1	5	1.25	30	<0.05

Mg	Mn	Na	Ni	Pb	Sb	Sn	Ti
1.25	25	40	2	0.75	1.25	0.5	2.5

V	Zn
0.5	5

Description

Made with pure (SiO₂), quartz microfibers completely free of bonding agents and later treated at high temperatures. Quartz fiber thimbles have enjoyed high demand over the last years due to the growing social concern over atmospheric contamination and the environment in general.

They have the same properties as quartz microfiber filters but its thimble the format makes it specially indicated in controls of emission in industrial smokestacks by means of isokinetic probes. Are also used for the retention of dust particles suspended in gases, aerosols, or generally in any analysis where a thimble resistant to high temperatures (up to 900°C) or chemically compatible with gases where high acid concentration is required (except HF)

Technical specifications

Ref.	Composition	Retention	DOP penetration	Max. Temperature	Binders
		% a 0.3 µm	% a 0.3 µm		
CQ2000	100% quartz microfiber	99.998	< 0.002	900°C	No

Quartz microfiber thimble's dimension ref. CQ2000



19 x 90	22 x 65	22 x 70	25 x 70	25 x 100	26 x 60	30 x 77	30 x 80	30 x 100	30 x 110	34 x 150	35 x 150	43 x 123
---------	---------	---------	---------	----------	---------	---------	---------	----------	----------	----------	----------	----------

Dimensions: Inner diameter x length in mm
Presentation: Packs of 25 units

INFORMATION FOR ORDERS. Quartz microfiber thimbles ref. CQ2000

Ø int x longitud (mm)	Code	units/box
19 x 90	CQ20001990	25
22 x 65	CQ20002265	25
22 x 70	CQ20002270	25
25 x 70	CQ20002570	25
25 x 100	CQ200025100	25
26 x 60	CQ20002660	25
30 x 77	CQ20003077	25
30 x 80	CQ20003080	25
30 x 100	CQ200030100	25
30 x 110	CQ200030110	25
34 x 150	CQ200034150	25
35 x 150	CQ200035150	25
43 x 123	CQ200043123	25

Papers for chromatography

Specially made as a holder in an enormous type of chromatography



Description

A range of papers made from cellulose chromatography pure cotton linters with an alpha cellulose content of 98% to ensure a low ash content and the virtual absence of metal contaminants, especially Fe and Cu, which could lead to interference.

These raw materials used in these papers confer the perfect regularity in the formation and the position and distribution of fibers, which allows a perfect uniformity of the physical characteristics of each quality. Also, a correct paper storage rear ensures good behavior in laboratory.

These papers are used primarily in processes of chromatography and electrophoresis, for separating a mixture of substances according to the principle of distribution extraction speeds. This is determined by the different sizes of the molecules, distribution coefficient and molecular charges.

The most important parameters that indicate the characteristics of the chromatographic papers are weight in grams, thickness and the speed of aspiration. While a heavier paper and thickness guarantee high solute load, speed of capillary suction ensures better definition but the opposite, so you will always have a role higher resolution slow.

The applications are vast: teaching organic chemistry (ion separation difficult to identify), determination of some compounds in industry, etc.

Technical specifications

Ref.	Grammage	Thickness	Aspiration speed
	g/m ²	mm	mm/30 min
PC 1 Thin, medium aspiration	90	0.18	90 - 100
PC 2 Thin, medium aspiration	140	0.28	90 - 100
PC 3 Medium, medium aspiration	180	0.36	90 - 100
PC 4 Thick, medium aspiration	270	0.70	130 - 140 ¹
PC 5 Very thick, quick aspiration	650	1.70	100 - 120 ¹

(1) mm/10 min

APPLICATIONS

Ref. PC1. Fine, medium aspiration

- General chromatography works
- Determination of the presence of malic acid in wine
- Practices in high schools' labs and universities' labs

Ref. PC2. Fine, medium aspiration

- General chromatography works
- Determination of components by elution

Ref. PC3. Medium, medium aspiration

- Separation of organic compounds
- Electrophoresis works
- Chromatography with a high charge of solutes
- Separation and identifications of additives in food.

Ref. PC4. Thick, fast aspiration

- Electrophoresis with big molecular compounds
- Analyses of proteins in serums

Ref. PC5. Very thick, fast aspiration

- Electrophoresis with very big molecular compounds

Formats and dimensions



100 x 150	120 x 140	150 x 200	200 x 200	460 x 570	580 x 600
-----------	-----------	-----------	-----------	-----------	-----------

Dimensions: Measures in mm
Presentation: Packs of 100 units

Other formats and dimensions available under demand

INFORMATION FOR ORDERS. Paper for Chromatography

PC 1 Thin, medium aspiration

Size mm	Cod.	units/pack
100 x 150	HJPC1100150	100
120 x 140	HJPC1120140	100
150 x 200	HJPC1150200	100
200 x 200	HJPC1200200	100
460 x 570	HJPC1460570	100
580 x 600	HJPC1580600	100

PC 2 Thin, medium aspiration

Size mm	Cod.	units/pack
100 x 150	HJPC2100150	100
120 x 140	HJPC2120140	100
150 x 200	HJPC2150200	100
200 x 200	HJPC2200200	100
460 x 570	HJPC2460570	100
580 x 600	HJPC2580600	100

PC 3 Medium, medium aspiration

Size mm	Cod.	units/pack
100 x 150	HJPC3100150	100
120 x 140	HJPC3120140	100
150 x 200	HJPC3150200	100
200 x 200	HJPC3200200	100
460 x 570	HJPC3460570	100
580 x 600	HJPC3580600	100

PC 4 Thick, quick aspiration

Size mm	Cod.	units/pack
100 x 150	HJPC4100150	100
120 x 140	HJPC4120140	100
150 x 200	HJPC4150200	100
200 x 200	HJPC4200200	100
460 x 570	HJPC4460570	100
580 x 600	HJPC4580600	100

PC 5 Very thick, quick aspiration

Size mm	Cod.	units/pack
100 x 150	HJPC5100150	100
120 x 140	HJPC5120140	100
150 x 200	HJPC5150200	100
200 x 200	HJPC5200200	100
460 x 570	HJPC5460570	100
580 x 600	HJPC5580600	100

Blotting paper

Recommended on the specific development of blotting techniques



Description

The blotting papers FILTER-LAB® are manufactured under very high quality standards. These papers are used exclusively for transfer in techniques of DNA, RNA, proteins, etc. The most important features are: uniform structure (weight and thickness), smooth surface, strength and ultrapure composition (made of cotton linters).

Aspiration levels are higher in the longitudinal direction of the fiber in the transverse direction; in the next step 470 or 600 mm. This papers come in different sizes for use with the most used transfer equipment..

Technical specifications

Ref.		Grammage	Thickness	Aspiration speed
		g/m ²	mm	mm/10 min
BLT 1	Medium, medium aspiration	180	0.36	55 - 65
BLT 2	Thick, quick aspiration	270	0.70	130 - 140
BLT 3	Very thick, quick aspiration	400	1.0	130 - 145

Formats and dimensions



93 x 80	100 x 70	130 x 100	150 x 200	200 x 200	210 x 90	460 x 570	580 x 600
---------	----------	-----------	-----------	-----------	----------	-----------	-----------

Dimensions: Measures in mm
Presentation: Packs of 100 units

Other formats and dimensions available under demand

APPLICATIONS

Ref. BLT1. Medium aspiration

- Northern, Southern y Western
- Dot blot, Slot blot
- The sequence of gen flow

Ref. BLT2.Thick, quick aspiration

- Western
- Cellular lysates

Ref. BLT3. Very thick, quick aspiration

- Protein identification by a semi-dry transference

INFORMATION FOR ORDERS. Blotting papers

BLT 1 Medium, medium aspiration

Size mm	Cod.	units/pack
93 x 80	HJBLT19380	100
100 x 70	HJBLT110070	100
130 x 100	HJBLT1130100	100
150 x 200	HJBLT1150200	100
200 x 200	HJBLT1200200	100
210 x 90	HJBLT121090	100
460 x 570	HJBLT1460570	100
580 x 600	HJBLT1580600	100

BLT 2 Thick, quick aspiration

Size mm	Cod.	units/pack
93 x 80	HJBLT29380	100
100 x 70	HJBLT210070	100
130 x 100	HJBLT2130100	100
150 x 200	HJBLT2150200	100
200 x 200	HJBLT2200200	100
210 x 90	HJBLT221090	100
460 x 570	HJBLT2460570	100
580 x 600	HJBLT2580600	100

BLT 3 Very thick, quick aspiration

Size mm	Cod.	units/pack
93 x 80	HJBLT39380	100
100 x 70	HJBLT310070	100
130 x 100	HJBLT3130100	100
150 x 200	HJBLT3150200	100
200 x 200	HJBLT3200200	100
210 x 90	HJBLT321090	100
460 x 570	HJBLT3460570	100
580 x 600	HJBLT3580600	100

Absorbent paper for paper industry ref. 1860

Recommended for the assay in the formation of sheets and the Cobb test



APPLICATIONS

- Determination of water absorption capacity in the manufacture of sized paper in the Cobb test according to ISO / R 535.
- Test sheet formation in pulp industry according to ISO 5269/1

Description

High absorption paper made especially for use in quality control laboratories in the paper industry. Basically used in the manufacture of pulp for testing sheet formation parameters as described by the norm ISO 5269/1. Moreover, also used in the manufacture of glued paper to perform the Cobb test as directed by the UNE 57-027 and ISO / R 535.

Technical specifications

Ref.	Grammage g/m ²	Thickness mm	Area absorption AFN 20535 (g/m ²)	Klemm absorption mm/10 min	Ash content %
1860	260	0.400	450 ± 50	80/75*	≤ 0.2

*Longitudinal sense /Transversal sense

Formats and dimensions



100 x 100	130 x 130	150 x 150	170 x 170	180 x 180	200 x 200	220 x 220
210 x 297	230 x 230	250 x 230	250 x 250	480 x 480*	420 x 520*	

Dimensions: Dimensions in mm

Presentation: Packs of 500 units, except 480 x 480* and 420 x 520* mm (100 units)

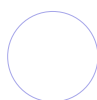

100	130	150	160	170	190	200	240
-----	-----	-----	-----	-----	-----	-----	-----

Dimensions: Diameter in mm

Presentation: Packs of 500 units

Other formats and dimensions available under demand.

INFORMATION FOR ORDERS. Absorbent paper for paper industry ref. 1860

Size: width x length mm	Cod.	units/pack	Size: Ø mm	Cod.	units/pack
100 x 100	HJ1860100100	500	100	PN1860100	500
130 x 130	HJ1860130130	500	130	PN1860130	500
150 x 150	HJ1860150150	500	150	PN1860150	500
170 x 170	HJ1860170170	500	160	PN1860160	500
180 x 180	HJ1860180180	500	170	PN1860170	500
200 x 200	HJ1860200200	500	190	PN1860190	500
220 x 220	HJ1860220220	500	200	PN1860200	500
210 x 297	HJ1860210297	500	240	PN1860240	500
230 x 230	HJ1860230230	500			
250 x 230	HJ1860250230	500			
250 x 250	HJ1860250250	500			
480 x 480	HJ1860480480	100			
420 x 520	HJ1860420520	100			

Papers for germination assays

Recommended for specific assays in seed laboratories



Description

The absorbent paper is nowadays the ideal medium for storing transporting and regulating moisture according to the most modern methods for determining the ability of seed germination. Every single paper for germination seed accomplish the standards determined by ISTA, International Seed Test Association.

Properties

Composition

Made with cellulose fibers of chemically bleached wood, linters or any other vegetable cellulose 100% free from chlorine.

Content in ashes

The ash content is 0.1%.

High absorption

Is a very important condition of these papers since they provide the medium for storing the moisture needed for seed development.

Resistance

This papers must withstand constant handling once the experiment starts. They are soaked in water so that is why they must have good resistance to the moist state. This is done by using an inert synthetic additive during the manufacturing process for the purpose of uniting the cellulose fibers.

Compact texture

The evenness of the surface of the paper ensures that the development of the seedling occurs on the surface of the paper, without the root penetrating into the fibrous structure.

pH

The pH from the aqueous extract from the paper must be between 6.0 – 7.5 . FILTER-LAB® germination papers accomplish that requirement.

Technical specifications

Ref.	Grammage g/m ²	Thickness mm	Klemm absorption mm/10 min	Wet resistance kN/m	Ash content %
516G	390	0.930	115/120	0.65/0.40	0.1
518G	155	0.500	110/115	0.70/0.60	0.1
519G	155	0.500	110/115	0.70/0.60	0.1
555G	120	0.220	100/100	0.40/0.25	0.1
305G	73	0.170	88/89	0.29/0.26	0.1

APPLICATIONS

Ref. 516G

- Method between papers, towels or Vienna roll with large seeds, the orchard or grain.

Ref. 518G

- Jacobsen's System or Copenhagen's tank.
- Germination bells with forestal seeds.

Ref. 519G

- Absorption stripes in germination bells.
- Absorption stripes in Copenhagen tank.

Ref. 555G

- Neeb assay with beetroot seeds.

Ref. 305G

- Method between papers, towels or Vienna roll.

Formats and dimensions ref. 516G

32 x 42	42 x 52
---------	---------

Dimensions: Measures in cm
Presentation: Packs of 500 units



75	85	88	90	95	130	160
----	----	----	----	----	-----	-----

Dimensions: Diameter in mm
Presentation: Packs of 100 units

Other formats and dimensions available under demand.

INFORMATION FOR ORDERS. 516G
516G Sheets

Size cm	Cod.	units/pack
32 x 42	RM516G3242	500
42 x 52	RM516G4252	500

516G Circles

∅ mm	Cod.	units/pack
75	PN516G075	100
85	PN516G085	100
88	PN516G088	100
90	PN516G090	100
95	PN516G095	100
130	PN516G130	100
160	PN516G160	100

Formats and dimensions ref. 518G

75	85	88	90	95	130	160
----	----	----	----	----	-----	-----

Dimensions: Diameter in mm
Presentation: Pack of 100 units

Other formats and dimensions available under demand.

INFORMATION FOR ORDERS. 518G
518G Circles

∅ mm	Cod.	units/pack
75	PN518G075	100
85	PN518G085	100
88	PN518G088	100
90	PN518G090	100
95	PN518G095	100
130	PN518G130	100
160	PN518G160	100

Formats and dimensions ref. 519G

30 x 200	18 x 320
----------	----------

Dimensions: Measures in mm
Presentation: Packs of 100 units

INFORMATION FOR ORDERS. 519G
519G Strips

Size mm	Cod.	units/pack
30 x 200	TR519G30200	100
18 x 320	TR519G18320	100

Formats and dimensions ref. 555G y 556G

Dimensions: Measures in mm
Presentation: Packs of 32 units

2000 x 110 x 20

INFORMATION FOR ORDERS. 555G, 556G

Size mm	color	Cod.	units/pack
2000 x 110 x 20	white	TR555G	32
2000 x 110 x 20	grey	TR556G	32

Formats and dimensions ref. 305G

11x 60	42 x 52
--------	---------

Dimensions: Measures in cm
Presentation: Packs of 100 units

INFORMATION FOR ORDERS. 305G
305G Sheets

Size cm	Cod.	units/pack
11 x 60	RM305G1160	500
42 x 52	RM305G4252	500

Drying papers

Absorption of liquids, transport of samples and other specific assays



APPLICATIONS

- Transport of biological samples.
- Absorption of spilled liquids.
- Absorption of the tint excess of inks in the graphic industry.
- Reduction of rupture risk of glass material in hard surfaces inside the laboratory.
- Restoration works in studios of all types of museums.
- Determination of water's retention power of mortars in paste by ISO 5269-1: 1998.
- Determination of resistance to cool liquids of lacked surfaces by potentiometries based on standard: UNE 89401.
- Absorption of liquids in animal cages.

Description

A family of absorbent paper of different weight in grams and thicknesses used for the transport of samples, absorption of liquids in laboratories, protection of surfaces, etc. Papers made with pure cellulose fibres and with a little bit of inert binder that makes this paper perfect for the moist state, avoiding the landslide of fibres.

Technical specifications

Ref.	Grammage	Thickness	Klemm absorption*
	g/m ²	mm	mm/10 min
S-100	100	0.240	78/75
S-160	160	0.380	60/0
S-190	185	0.410	88/93
S-300	295	0.650	78/70
S-400	390	0.930	115/120
S-450	450	0.999	127/120
S-500	500	1.138	105/110
S-600	600	1.500	110/102
S-720	720	1.800	115/110

* Longitudinal sense / Transversal sense

Formats and dimensions



10 x 10	10 x 15	20 x 20	32 x 42	42 x 52	58 x 58
---------	---------	---------	---------	---------	---------

Dimensions: Measures in cm
Presentation: packs of 100 units



25

Dimensions: Diameter in mm
Presentation: Packs of 1.000 units

Other formats and dimensions available under demand.

INFORMATION FOR ORDERS. Drying papers

S-100 (100 g/m²)

Size cm	Cod.	units/pack
10 x 10	HJS1001010	100
10 x 15	HJS1001015	100
20 x 20	HJS1002020	100
32 x 42	HJS1003242	100
42 x 52	HJS1004252	100
58 x 58	HJS1005858	100
∅ Size mm	Cod.	units/pack
25	-	-
47	PNS100047	100
100	PNS100100	100
110	PNS100110	100
150	PNS100150	100
200	PNS100200	100

S-160 (160 g/m²)

Size cm	Cod.	units/pack
10 x 10	HJS1601010	100
10 x 15	HJS1601015	100
20 x 20	HJS1602020	100
32 x 42	HJS1603242	100
42 x 52	HJS1604252	100
58 x 58	HJS1605858	100
∅ Size mm	Cod.	units/pack
25	-	-
47	PNS160047	100
100	PNS160100	100
110	PNS160110	100
150	PNS160150	100
200	PNS160200	100

S-190 (185 g/m²)

Size cm	Cod.	units/pack
10 x 10	HJS1901010	100
10 x 15	HJS1901015	100
20 x 20	HJS1902020	100
32 x 42	HJS1903242	100
42 x 52	HJS1904252	100
58 x 58	HJS1905858	100
∅ Size mm	Cod.	units/pack
25	-	-
47	PNS190047	100
100	PNS190100	100
110	PNS190110	100
150	PNS190150	100
200	PNS190200	100

S-300 (300 g/m²)

Size cm	Cod.	units/pack
10 x 10	HJS3001010	100
10 x 15	HJS3001015	100
20 x 20	HJS3002020	100
32 x 42	HJS3003242	100
42 x 52	HJS3004252	100
58 x 58	HJS3005858	100
∅ Size mm	Cod.	units/pack
25	-	-
47	PNS300047	100
100	PNS300100	100
110	PNS300110	100
150	PNS300150	100
200	PNS300200	100

S-400 (390 g/m²)

Size cm	Cod.	units/pack
10 x 10	HJS4001010	100
10 x 15	HJS4001015	100
20 x 20	HJS4002020	100
32 x 42	HJS4003242	100
42 x 52	HJS4004252	100
58 x 58	HJS4005858	100
∅ Size mm	Cod.	units/pack
25	-	-
47	PNS400047	100
100	PNS400100	100
110	PNS400110	100
150	PNS400150	100
200	PNS400200	100

S-450 (450 g/m²)

Size cm	Cod.	units/pack
10 x 10	HJS4501010	100
10 x 15	HJS4501015	100
20 x 20	HJS4502020	100
32 x 42	HJS4503242	100
42 x 52	HJS4504252	100
58 x 58	HJS4505858	100
∅ Size mm	Cod.	units/pack
25	PNS450025R	1000
47	PNS450047	100
100	PNS450100	100
110	PNS450110	100
150	PNS450150	100
200	PNS450200	100

S-500 (500 g/m²)

Size cm	Cod.	units/pack
10 x 10	HJS5001010	100
10 x 15	HJS5001015	100
20 x 20	HJS5002020	100
32 x 42	HJS5003242	100
42 x 52	HJS5004252	100
58 x 58	HJS5005858	100
∅ Size mm	Cod.	units/pack
25	-	-
47	PNS500047	100
100	PNS500100	100
110	PNS500110	100
150	PNS500150	100
200	PNS500200	100

S-600 (600 g/m²)

Size cm	Cod.	units/pack
10 x 10	HJS6001010	100
10 x 15	HJS6001015	100
20 x 20	HJS6002020	100
32 x 42	HJS6003242	100
42 x 52	HJS6004252	100
58 x 58	HJS6005858	100
∅ Size mm	Cod.	units/pack
25	-	-
47	PNS600047	100
100	PNS600100	100
110	PNS600110	100
150	PNS600150	100
200	PNS600200	100

S-720 (720 g/m²)

Size cm	Cod.	units/pack
10 x 10	HJS7201010	100
10 x 15	HJS7201015	100
20 x 20	HJS7202020	100
32 x 42	HJS7203242	100
42 x 52	HJS7204252	100
58 x 58	HJS7205858	100
∅ Size mm	Cod.	units/pack
25	-	-
47	PNS720047	100
100	PNS720100	100
110	PNS720110	100
150	PNS720150	100
200	PNS720200	100

Sterilization paper

Sterilization of surgical disposables in hospitals



Description

A white crepe paper 60 g/m², soft and porous, used in clinics and hospitals for sterilization by autoclave, radiation or ethylene oxide, of instrumentation, medical clothing and other materials for surgical use, protecting against pollution after sterilization process.

Made of pure cellulose with a rough surface that gives high flexibility, which facilitates handling.

It is manufactured in accordance with EN 868-1 and EN 868-2.

Technical specifications

Ref.	Grammage	Thickness	Cobb absorption	Wet resistance
	g/m ²	mm	mm/10 min	kN/m
1650B	60	0.160	16 - 18	0.300/0.200

Formats and dimensions



30 x 30	45 x 45	50 x 50	60 x 60	75 x 75	90 x 90	100 x 100	120 x 120	130 x 130	120 x 150
---------	---------	---------	---------	---------	---------	-----------	-----------	-----------	-----------

Dimensions: Measures in cm
Presentation: According to the dimensions



60 x 200

Dimensions: Width in cm x length in meters
Presentation: Unit

INFORMATION FOR ORDERS. White absorbent paper for sterilization ref. 1650B

Format	Size: width x length (cm)	Cod.	units/pack
Sheets	30 x 30	HJ1650B3030	2.000
Sheets	45 x 45	HJ1650B4545	500
Sheets	50 x 50	HJ1650B5050	500
Sheets	60 x 60	HJ1650B6060	500
Sheets	75 x 75	HJ1650B7575	250
Sheets	90 x 90	HJ1650B9090	250
Sheets	100 x 100	HJ1650B100100	250
Sheets	120 x 120	HJ1860250230	100
Sheets	130 x 130	HJ1860250250	100
Sheets	120 x 150	HJ1860480480	100
Rolls	60 cm width x 200 meters	BB1650B60200	Unit

APPLICATIONS

- Protective packaging for sterilization and conditioning of surgical disposables in hospitals.

Protector paper for stretchers ref. SRC

Protection stretchers in health centers, hospitals, cosmetics, etc..



APPLICATIONS

- Protection stretchers and examination tables

Description

Protective paper of high-quality, made exclusively with virgin cellulose fibers pine and eucalyptus entirely without chlorine. The third generation resin used in the manufacture of this product is approved for contact with food and people according to the following recommendations:

BGA XXXVI B. III.3 (c) y XXXVI/1 II.B.2 (c) y BGW XXXVI/1 Germany, 21 CFR Cap. 1, Sec. 176.170 y 176.180 FDA (max. dosification 1.5% on dry), VGB Ch. II. 1.2.2m Netherlands, CEE/CEPAC 3.2.e (c).

Its use is particularly suitable as a protector of stretchers and examination tables resistance centers, clinics and hospitals.

Formats and dimensions

50	58
----	----



Dimensions: Measures in cm
Presentation: Boxes of 6 reels

Other formats and dimensions available under demand.

INFORMATION FOR ORDERS. Protector paper for stretchers ref. SRC

Cod.	width (cm)	weight/roll (kg)	roll/carton
BBSRC50	50	2	6
BBSRC58	58	2.3	6

Cellulose stoppers

Protection and lockout of samples in flasks, test tubes and tubes for experiments



APPLICATIONS

- Lockout an protection of any type of sample, crops, microbiological or chemical, in Erlenmeyer flasks, bottles, test tubes, flasks or tubes for experiments

Description

Made exclusively with fibers of pure cellulose. Are the most practical, economical and hygienic solution to protect any type of sample: crops, microbiological or chemical, in Erlenmeyer flasks, bottles, test tubes, flasks or tubes for experiments.

Properties

- Sterilizable up to a maximum temperature of 200°C.
- Permeable in air .
- Perfectly adjusted to the container's mouth.
- Hygienic (this is a single-use material).
- Wide range of forms and dimensions.

How to choose the right model?

The only important as choosing the appropriate reference, is that corresponding to the inner diameter of the glass tube where you will insert the cellulose stopper.

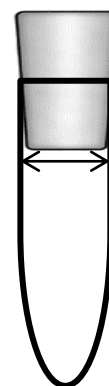

Formats and dimensions

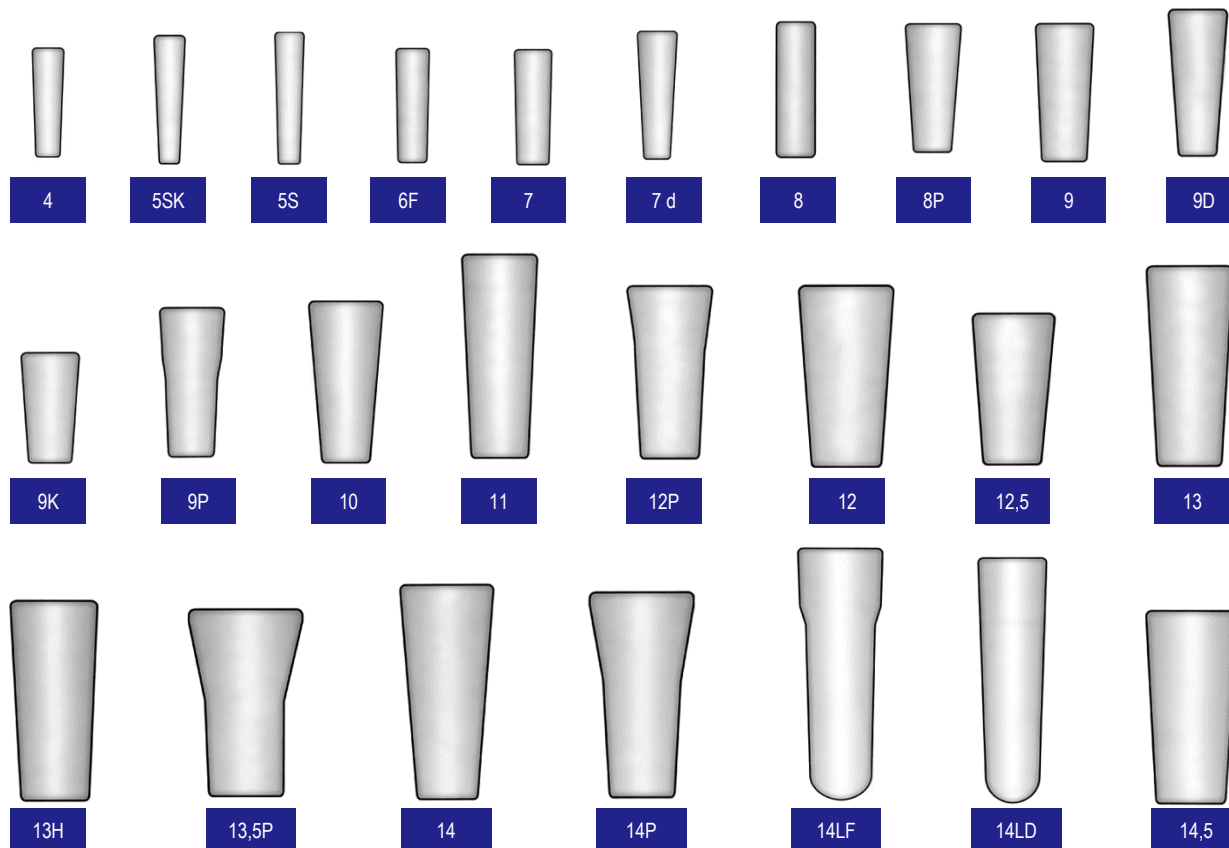



15



15P

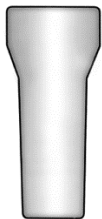

15PB



15P largo



15F



15E



15DD



16

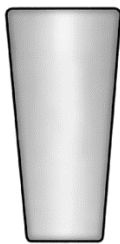

17



18D



18

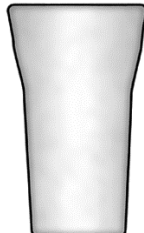

18P



18 largo



19



20



20M



20P



20A



21,5



22 corto



22 largo



23,5P

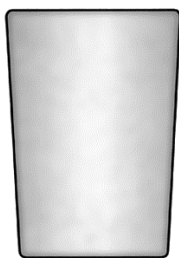

26

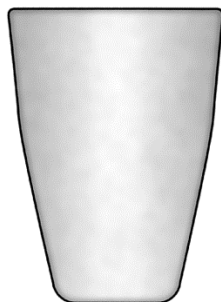

27



29A



29

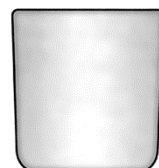

29K

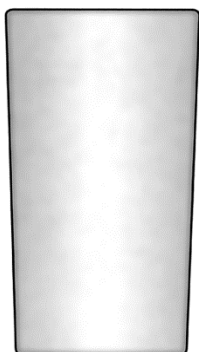

32

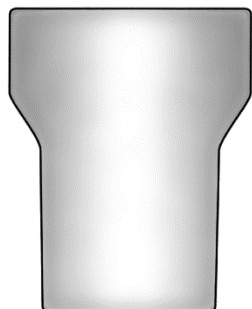

32P

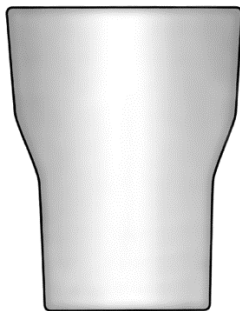

32PD

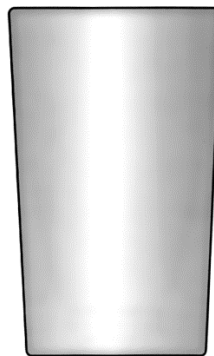

34

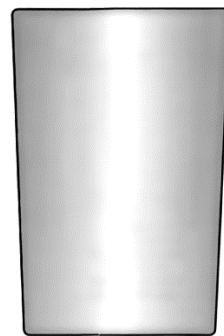

36

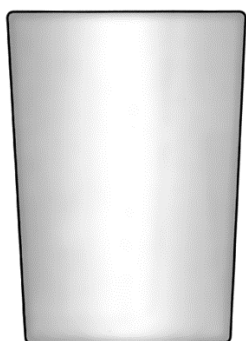

37

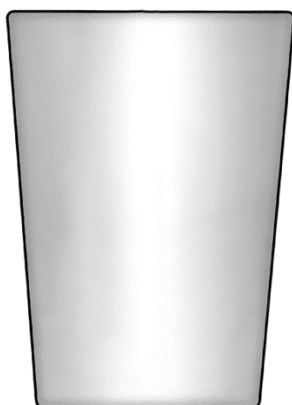

38

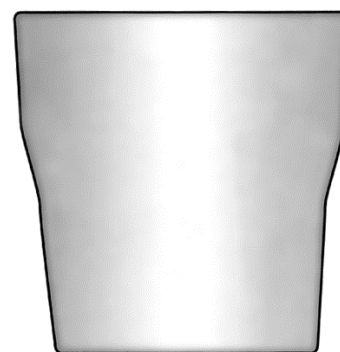

40P



45P

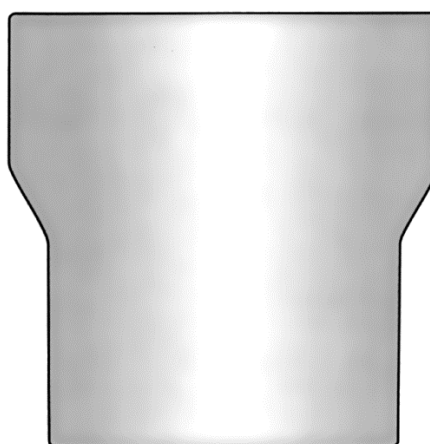

60P

INFORMATION FOR ORDERS. Cellulose stoppers

Code	Size \varnothing int. Tube	Units/pack
TP4	6.5 - 7.0	5.000
TP5SK	4.5 - 6.5	5.000
TP5S	5.5 - 6.5	5.000
TP6F	6.5 - 7.5	5.000
TP7	8.5 - 9.5	5.000
TP7D	7.5 - 8.5	4.000
TP8	9.5	2.000
TP8P	7.5 - 10.5	2.000
TP9	10.5 - 11.5	2.000
TP9D	7.0 - 9.5	2.000
TP9P	9.0 - 10.5	2.000
TP9K	8.5 - 10.2	2.000
TP10	9.5 - 11.5	1.000
TP11	12.0 - 14.5	1.000
TP12P	11.5 - 13.0	1.000
TP12	11.5 - 13.5	1.000
TP12,5	10.5 - 12.5	1.000
TP13	12.5 - 14.5	1.000
TP13H	12.5 - 13.5	1.000
TP13,5P	13.5 - 14.5	1.000
TP14	13.0 - 14.5	1.000
TP14P	12.0 - 14.0	1.000
TP14LF	14.0 - 16.0	4.000
TP14LD	12.0 - 14.5	4.000
TP14,5	14.0 - 16.0	1.000
TP15	13.5 - 15.5	1.000
TP15P	13.5 - 15.5	5.000
TP15PB	14.5 - 15.5	4.000
TP15P long	14.7 - 15.5	4.000
TP15F	13.5 - 16.0	5.000
TP15E	15.5 - 17.0	5.000
TP15DD	14.0 - 16.5	5.000

Code	Size \varnothing int. Tubo	Units/pack
TP16	16.5 - 18.0	5.000
TP17	13.0 - 16.0	1.000
TP18	17.5 - 18.5	500
TP18D	17.5 - 19.5	500
TP18P	17.5 - 19.5	500
TP18 long	17.0 - 19.0	3.000
TP19	19.0 - 22.0	2.500
TP20	20.5 - 22.0	450
TP20M	18.5 - 19.5	500
TP20P	19.0 - 22.5	2.500
TP20A	20.5 - 22.5	500
TP21,5	17.5 - 21.5	3.000
TP22 short	21.5 - 23.0	500
TP22 long	22.0 - 24.0	2.000
TP23,5P	25.0 - 27.0	2.000
TP26	26.0 - 27.0	2.000
TP27	27.0 - 32.5	1.000
TP29A	29.0 - 30.0	1.500
TP29	27.0 - 32.5	1.000
TP29K	26.0 - 27.0	2.500
TP32	32.5 - 35.0	800
TP32P	32.0 - 33.0	750
TP32PD	30.0 - 32.5	750
TP34	33.5 - 36.5	750
TP36	35.5 - 39.5	600
TP37	37.5 - 41.5	600
TP38	40.0 - 43.5	500
TP40P	42.0 - 46.5	500
TP45P	47.0 - 48.0	300
TP60P	57.0 - 60.0	200

Indicator papers and reagents

Determination of pH in field tests or routine tasks in industry



APPLICATIONS

- Quick determination of the pH value in industrial applications.
- Routine field analyses or outside the laboratory.
- Schools and high school practices.

Description

Nowadays, there are modern systems to calculate the pH value. Nonetheless, it is sometimes very important to have a simple, immediate and inexpensive method to quickly measure the pH in routine or field analyses.

FILTER-LAB® offers a wide range of pH indicator paper and strips or rolls, with different ranges and intervals according to the requirements of each case. The range is completed with moisture sensitive paper, litmus paper and some tests of qualitative detection.

TECHNICAL SPECIFICATIONS AND INFORMATION FOR ORDERS

Indicator papers

Format/material	Det.	Colors	Range	Interval	Scale values										Presentation	Code						
															units/pack							
Paper strips	pH	1	0.5 - 5.5	0.5	0.5	1.0	1.5	2.0	2.5	3.0	3.5	4.0	4.5	5.0	5.5	200	TR1911F01					
Paper strips	pH	1	3.8 - 5.8	0.2 - 0.3		3.8	4.1	4.5	4.7	4.9	5.2	5.5	5.8			200	TR1911F02					
Paper strips	pH	1	4.0 - 7.0	0.5		4.0	4.5	5.0	5.5	6.0	6.5	7.0				200	TR1911F03					
Paper strips	pH	1	5.0 - 9.0	0.5		5.0	5.5	6.0	6.5	7.0	7.5	8.0	8.5	9.0		200	TR1911F04					
Paper strips	pH	1	5.4 - 7.0	0.3		5.4	5.7	6.0	6.3	6.6	7.0					200	TR1911F05					
Paper strips	pH	1	6.4 - 8.0	0.3		6.4	6.7	7.0	7.2	7.4	7.7	8.0				200	TR1911F06					
Paper strips	pH	1	6.5 - 10.0	0.3		6.5	7.0	7.5	8.0	8.5	9.0	9.5	10.0			200	TR1911F13					
Paper strips	pH	1	7.2 - 9.7	0.3		7.2	7.5	8.0	8.5	8.8	9.2	9.7				200	TR1911F07					
Paper strips	pH	1	8.0 - 10.0	0.2 - 0.4		8.0	8.2	8.4	8.7	9.0	9.2	9.6	10.0			200	TR1911F14					
Paper strips	pH	1	9.0 - 13.0	0.5		9.0	9.5	10.0	10.5	11.0	11.5	12.0	12.5	13.0		200	TR1911F08					
Paper strips	pH	1	12.0 - 14.0	0.5		12.0	12.5	13.0	13.5	14.0						200	TR1911F09					
Paper strips	pH	1	1 - 14	1.0		1	2	3	4	5	6	7	8	9	10	11	12	13	14	200	TR1911F10	
Paper strips	pH	1	1 - 10	1.0			1	2	3	4	5	6	7	8	9	10				200	TR1911F11	
Paper strips	pH	1	1 - 14	1.0			1	2	3	4	5	6	7	8	9	10	11			200	TR1911F12	
Paper strips	pH	1	1 - 14	1.0			1	2	3	4	5	6	7	8	9	10	11	12	13	14	200	911S
Plastic strips	pH	4	1 - 14	1.0			1	2	3	4	5	6	7	8	9	10	11	12	13	14	100	920S
Paper rolls	pH	1	0.5 - 5.0	0.5		0.5	1.0	1.5	2.0	2.5	3.0	3.5	4.0	4.5	5.0						1	RL1911R01
Paper rolls	pH	1	5.0 - 9.0	0.5		5.0	5.5	6.0	6.5	7.0	7.5	8.0	8.5	9.0							1	RL1911R02
Paper rolls	pH	1	9.0 - 13.0	0.5		9.0	9.5	10.0	10.5	11.0	11.5	12.0	12.5	13.0							1	RL1911R03
Paper rolls	pH	1	0 - 10.0	1.0			0	1	2	3	4	5	6	7	8	9	10				1	RL1911R04
Paper rolls	pH	1	1 - 10.0	1.0			1	2	3	4	5	6	7	8	9	10					1	RL1911R05
Paper rolls	pH	1	1 - 14.0	1.0			1	2	3	4	5	6	7	8	9	10	11	12	13	14	1	RL1911R06

Replacement: paper rolls without housing

Format/material	Det.	Colors	Range	Interval	Scale values										Presentation	Code				
					0.5	1.0	1.5	2.0	2.5	3.0	3.5	4.0	4.5	5.0						
Paper rolls	pH	1	0.5 - 5.0	0.5	0.5	1.0	1.5	2.0	2.5	3.0	3.5	4.0	4.5	5.0	3	RC-RL01				
Paper rolls	pH	1	5.0 - 9.0	0.5	5.0	5.5	6.0	6.5	7.0	7.5	8.0	8.5	9.0	3	RC-RL02					
Paper rolls	pH	1	9.0 13.0	0.5	9.0	9.5	10.0	10.5	11.0	11.5	12.0	12.5	13.0	3	RC-RL03					
Paper rolls	pH	1	0 - 10.0	1.0	0	1	2	3	4	5	6	7	8	9	10	3	RC-RL04			
Paper rolls	pH	1	1 - 10.0	1.0	1	2	3	4	5	6	7	8	9	10	3	RC-RL05				
Paper rolls	pH	1	1 - 14.0	1.0	1	2	3	4	5	6	7	8	9	10	11	12	13	14	3	RC-RL06

Litmus paper

Description	Determination	Format	Presentation	Code
			units./pack	
Blue litmus paper	Control of the pH tendence	strips	200	TR916LB
Red litmus paper	Control of the pH tendence	strips	200	TR916LR
Blue litmus paper	Control of the pH tendence	roll	Roll 5 meters	RL916LB
Red litmus paper	Control of the pH tendence	roll	Roll 5 meters	RL916LR

Qualitative detection test

Description	Determination	Format	Size	Presentation	Code
			mm	units/pack	
Hidrosensible paper	Humidity presence	sheets	78 x 40	50	HJ989W/7840
Potassium iodide paper	Nitrite and free chlorine detection	strips		200	TR925
Turmeric paper	Boric acid detection	strips		200	TR926
Papel ioduro potásico	Detección de nitritos y cloro libre	roll		Roll 5 meters	RL925
Turmeric paper	Boric acid detection	roll		Roll 5 meters	RL926

Paper for weighing ref. 1200HP

Smooth stand to weigh solid or granulated substances



Smooth paper, semitransparent and with satin appearance. Ideal for the weighing of all types of substances.

APPLICATIONS

- Weighing of all type of substances.
- Handling of pharmaceutical products

Formats and dimensions



50 x 50	75 x 75	100 x 100	150 x 150	200 x 200
---------	---------	-----------	-----------	-----------

Dimensions: Measures in mm
Presentation: Packs of 500 units

Other formats and dimensions available under demand.

INFORMATION FOR ORDERS. Weighing paper ref. 1200HP

Cod.	Size (mm)	units/pack
HJ12005050	50 x 50	500
HJ12007575	75 x 75	500
HJ1200100100	100 x 100	500
HJ1200150150	150 x 150	500
HJ1200200200	200 x 200	500

Containers of paper for weighing free of nitrogen ref. 1200 RP

Weighing of substances before the nitrogen determination by Kjeldahl method.



Small containers of parchment paper prepared for the weighing of viscous or pasty substances before the nitrogen determination by Kjeldahl method.

APPLICATIONS

- Weighing of all type of substances.
- Handling of pharmaceutical products.

Formats and dimensions



58 x 10 x 10	70 x 23 x 15
--------------	--------------

Dimensions: Length x width x height in mm
Presentation: Packs of 100 units



INFORMATION FOR ORDERS. Weighing paper ref. 1200RP

Cod.	Size: length x width x high	units/pack
	mm	
RC1200581010	58 x 10 x 10	100
RC1200702315	70 x 23 x 15	100

Aluminum trays for weighing ref. 1200BP

Aluminum trays for weighing substances.



Practical trays for the weighing of all types of products in manual, electronic scales and dehydrators.

APPLICATIONS

- Weighing of all types of substances.
- Handling of pharmaceutical products

Formats and dimensions



56	72	93
----	----	----

Dimensions: Inner diameter in mm.
Presentation: Packs of 500 units.

Other formats and dimensions available under demand.

INFORMATION FOR ORDERS. Trays for weighing ref. 1200BP

Code	Diameter (mm)	units/box
BP1200056	56	500
BP1200072	72	500
BP1200093	93	500

Rolls of aluminum paper ref. 1200AP

Weighing of substances and protection of containers



An aluminium paper of 11 microns thickness in rolls of different width for the weighing of products and solid materials. Available with dispenser.

APPLICATIONS

- Weighing of all types of substances.
- Protection of containers.

Formats and dimensions



25 x 300	29 x 300	40 x 300
----------	----------	----------

Dimensions: Width (cm) x length (meters)
Presentation: Units

INFORMATION FOR ORDERS. Rolls of aluminium paper ref. 1200AP

Cod.	Size: width x length (cm x meters)	Rolls/pack
RL120025300/D	25 x 300	4
RL120029300/D	29 x 300	4
RL120040300/D	40 x 300	4

Blocks of paper for drying samples ref. 1439

Drying of liquid excess in microscopic preparations



Description

Thick and very absorbent paper strips used for the aspiration of excess liquids in microscopic preparations or in any drying samples.

APPLICATIONS

- Aspiration of excess liquids in microscopic preparations and of all types.

Formats and dimensions



40 x 100

Dimensions: Measures in mm
Presentation: Packs of 100 units

Other formats and dimensions available under demand.

INFORMATION FOR ORDERS. Strips blocks of paper for drying samples ref. 1439

Cod.	Size (mm)	units/pack
TR143940100	40 x 100	100

Joseph paper ref. 1443

Multiple drying applications and laboratory protection



Description

A very fine and mild paper used frequently for drying and cleaning glass containers in laboratories: flasks, tubes, Erlenmeyer flask, glass of precipitate, etc.

APPLICATIONS

- Drying and cleaning of the glazing shop in the laboratory.
- Storing of glass pieces and instruments.

Formats and dimensions



35 x 46

Dimensions: Measures in cm
Presentation: Packs of 500 sheets

INFORMATION FOR ORDERS. Joseph paper ref. 1443

Cod.	Size (width x length) cm	units/pack
HJ14433546	35 x 46	500

Lens cleaning paper ref. 1482

Cleaning of all type of optical lens



Description

Very fine and mile paper, made exclusively with very long fibres to be used as a cleaning cloth for optical lens. Does not leave fibres. Does not scratch.

INFORMATION FOR ORDERS. Lens cleaning paper ref. 1482

Cod.	Size (mm)	units/pack
CP1482100150	100 x 150	500

APPLICATIONS

- Cleaning of all types of optical lens: microscopes, binoculars, lens, magnifying glasses, eyeglasses, etc.
- Cleaning the filaments of optical fiber before the chemical or thermal soldering.

Formats and dimensions



100 x 150

Dimensions: Measures in mm
Presentation: Packs of 500 units

Other formats and dimensions available under demand.

Paper for cytological analyses

Absorption of liquid excess in cyto centrifuges.



Description

In cytological analyses with cyto centrifuges, the blotting paper is used to absorb the liquid remaining from the staining of the sample, with which the microscope slide remains completely dry.

INFORMATION FOR ORDERS. Paper for cytological analyses

Cod.	Dimensions	units/pack
CT14312575	25 x 75 mm with 2 holes	200



Cod.	Dimensions	units/pack
CT14324526	46 x 26 mm with 1 hole	200



Cod.	Dimensions	units/pack
CT14336326	63 x 26 mm with 1 hole	200



APPLICATIONS

- Absorption of liquids from the staining of samples in cytological analyses with cyto centrifuges.

Formats and dimensions

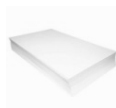

25 x 75 with 2 holes

45 x 26 with 1 hole

63 x 26 with 1 hole

Dimensions: Measures in mm
Presentation: Pack of 200 sheets

Paper for smelling tests ref. 1228

Smelling tests with perfumes, flavoring, essences, etc.



APPLICATIONS

- Smelling tests with perfumes, scents, essences, etc.

Description

An absorbent paper made with high-quality linters and cellulose. During the production and handling process, they are carefully protected from any type of contamination, which makes them ideal for use in laboratories where smelling tests are carried out. This paper, thanks to the good evenness of its surface, can be printed for the insertion of any text or commercial logo.

Technical specifications

Ref.	Grammage	Thickness
	g/m ²	mm
1228	250	0.58

Formats and dimensions



8 x 150

Dimensions: Measures in mm
Presentation: Packs of 1.000 units

Other formats and dimensions available under demand.

INFORMATION FOR ORDERS. Paper for smelling tests ref. 1228

Size mm	Cod.	units/pack
8 x 150	TR12288150	1000

Antibiotic test paper ref. 1468

Recommended for resistance test of pathogen organisms



APPLICATIONS

- Impregnation of antibiotics for resistance test of pathogen organisms.

Description

Absorbent paper circles without impregnation and very pure. Provided in 6, 9 and 13mm diameter for its use in antibiotic test.

Formats and dimensions



6	9	13
---	---	----

Dimensions: Diameter en mm
Presentation: Packs of 1.000 units



20 x 20	40 x 40	60 x 60
---------	---------	---------

Dimensions: Measure in cm
Presentation: Packs of 100 units

Other formats and dimensions available under demand.

INFORMATION FOR ORDERS. Antibiotic test paper ref. 1468

Format	Diameter (mm)	Code	units/box
Circles	6	PN1468006	1.000
Circles	9	PN1468009	1.000
Circles	13	PN1468013	1.000
Size: width x length (cm)		Code	units/box
Sheets	20 x 20	HJ14682020	100
Sheets	40 x 40	HJ14684040	100
Sheets	60 x 60	HJ14686060	100

Filter auxiliaries

Filtration of samples difficult to clarify



Description

Filter auxiliaries products are very useful in saving time in the process of difficult simple filtration or in specific investigations when the filtration time has to be brief. The filter auxiliaries available in the FILTER-LAB brand are the following:

Diatomaceous earth (Kieselgur)

They are extracted of white sedimentary rocks, of very porous structure and therefore light. They are formed by the accumulation of siliceous shells of algae in the fossil state. They have been used for years as filter auxiliaries in polishing processes in the manufacture of edible oils, wines, alcohols, pharmaceutical products, etc. due to its excellent absorption properties. In the filtration of laboratory samples we found its usefulness in combination with a filter paper with a smaller pore size than the measurement of the size of kieselguhr particles (see table). It can even be used together with FILTER-LAB diatom filter paper ref. 1297. This auxiliary is especially interesting in the filtration of difficult samples with particles of colloidal size.

Ref.	Retention	Earths dimensions	Permeability	Filtration
	µm	µm	darcies	
TD60	1.2	66	6.5	Fast
TD12	0.7	24	0.8	Medium
TD1 SL	0.1	13	0.07	Slow

Cellulose fibers

Composed of long and short fibers of cellulose plus cotton linters of high purity, being the same raw material as filter papers for qualitative and quantitative analysis. The sample to be filtered can be mixed with the cellulose fibers, forming a suspension which favors the flocculating effect. It may also be used to form a prefiltration bed in the funnel. Of course it should be used in combination with a slow speed filter paper. According to the ashes content of the cellulose fibers, these can be quantitative or qualitative.

Ref.	Quality	Ash content
FB/CT	Quantitative	< 0.01%
FB/CL	Qualitative	< 0.2%

Cellulose trimmings

Filter paper trimmings, either quantitative or qualitative with different filtration speeds. With them, you can form a filter bed in the bottom of the funnel, what causes a more effective retentive effect.

Ref.	Quality	Ash content
RCT/500	Quantitative	< 0.01%
RCL/500	Qualitative	< 0.2%

INFORMATION FOR ORDERS

Diatomaceous earth

Code	Quantity/pack
TD60500	500 grams
TD12500	500 grams
TD1SL500	500 grams

Fibras de celulosa

Code	Quality	Quantity/pack
FBCT1000	Quantitative	1 kg
FBCL1000	Qualitative	1 kg

Cellulose trimmings

Code	Quality	Quantity/pack
RCT/500	Quantitative	500 grams
RCL/500	Qualitative	500 grams

APPLICATIONS

- Filtration of samples with gelatinous particles
- Filtration of samples with semicoloidal particles that difficult the separation process
- Filtration of heavy hydroxides and sulfides
- Polishing of dirty samples

Technical filtering papers and cardboards

Filtration of chemical products, pharmaceutical, cosmetics, coloring, fats, emulsions, juices, liquors, etc.



Description

Furthermore to the range of FILTER-LAB® laboratory filters, Filtros Anoaia, S.A. manufactures and markets a wide range of filter papers for industrial use that are used in various sectors for the filtration of all types of liquids: chemical products, mineral and vegetable oils, coloring agents, fats, emulsions, juices wines, galvanic baths, essences, etc.

We make smooth and creased filtering papers and cardboards with quick, medium or slow velocities of filtration for specific applications or according to standard methods, starting from weights in grams from 44 to 600 gr./m² and all of these handled and die-cut at the dimensions requested by customers in customary or special formats.



Properties

- Excellent charge capacity.
- A 15-20% more filtrating surface than a smooth paper.
- Higher resistance to the moist state.
- Avoid the premature silting.
- Limited grammage: from 45 to 240gr./m².

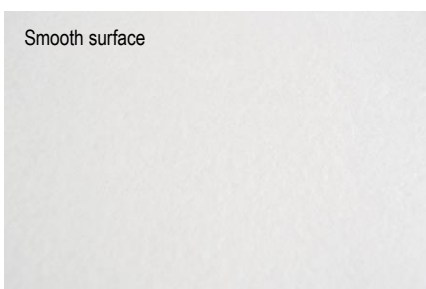

Properties

- More regular pores.
- Very homogeneous formation.
- Good charge capacity.
- Very wide range: from 45 to 600 gr./m².

Crepe technical filter papers

Ref.	Grammage g/m ²	Thickness mm	Applications
1535 CT	50	0.185	Dye for textile fibers.
1591	64	0.165	Solutions with sugar with low concentration
F60	60	0.250	Filtration of infusions, emulsions and food
1525 CR	73	0.285	Chemical products, essentials oils Filtration of industrial colored, galvanic industry.
1526M	87	0.370	Solutions a little bit acid or alkaline
1526	90	0.330	Galvanic industry Galvanic industries, seed oils
1526P	90	0.390	Solutions a little bit acid or alkaline Filtration quicker than the earlier. Galvanic industry
1518/110	110	0.320	Recovery of precious metals, filtration of seed oils.
1518/120	120	0.340	Filtration of technical fats, moods, and sunflower oils.
1518/140W	132	0.550	Industrial chemical products and fine chemistry.
1518/140	140	0.450	Very dense edible oils, animal fats, concentrated essences.
B150	150	0.550	Filtration of juices, grape-juices, wines, galvanic industry, etc.
1518/156	156	0.550	Chemical products, liquid foods
1518/160	160	0.450	Syrups, essential oils, butters...
1518/190	185	0.650	Distiled and liquors.
1518/190W	185	0.650	Polishment on virgin olive oils, glicerines and galvanic industry.
1518/240	240	0.780	Chemical products Polishment on virgin olive oils, glicerines and galvanic industry.

Smooth technical filter papers

Ref.	Grammage g/m ²	Thickness mm	Applications
1300G	85	0.180	Prefiltration before filter disks
SM90	90	0.190	Retention of carbon active particles, mineral waters and very fine particles.
1055	100	0.240	Essences filtration, galvanizing industry. Protection of disks in filter presses for wines, liquors, vinegars, etc.
1300/110	110	0.250	Quick filtration of large volumes for the retention of thick particles. Filtration of emulsions and ink.
1301/125	125	0.250	Chemical products
1301/140	140	0.290	Resines, lacquers and additives
F150	150	0.300	Water from boilers and clear liquids
1320	160	0.470	Syrups, margarines, fats
1301/160	160	0.380	Filtration of turbid liquids, extracts and juices.
1301/190	185	0.410	Filtration of chemical products and edible oils. Absorbents in the graphic industry.
1301/190S	185	0.400	High resistance to moist state. Filtration in press filters with high pressure
1301/250	250	0.580	Clarification of liquids, oils and cosmetics.
1301/250F	250	0.560	Medium filtration. High resistance to moist state
1301/280	280	0.444	Filtration of mineral oils, hydrocarbons, lacquers...
1301/300	290	0.630	Mineral oils (big motors, machines, electrical transformers) Hydrocarbons, lacquers, etc.
1301/320	320	0.880	Turbines oils, transformers, hydraulics, motor lubricants
1301/350	350	0.780	Medium filtration. Very resistant to the moist state
1301/350K	350	0.730	Very slow filtration. Final filtration of clear water, polishing of fine chemicals Galvanic industry, very dense and dirty mineral oils.
1516P	375	0.980	Galvanic industry, oils, turbid mineral oils.
1516	390	0.930	Absorbent for liquids Same as 1516 but with increased wet strength
1516WR	390	0.930	Filtration of food additives, fine filtration of mineral waters
1301/400	400	0.750	Filtration of clear and low density liquids Filtration or clarifications in the chemical industry.
1301/450	450	0.990	Alcohols, filtration of water from boilers. Polishing of edible oils, soaking of industrial substances.
1301/500	500	1.130	Carbon active paper. Liquids bleaching, galvanic industry
1345	160	0.400 - 0.450	Chemical products Active carbon filter paper, food grade
1346	170	0.450 - 0.500	Papel con carbón activo, grado alimentario

Filter sheets

Filtration of chemical products, pharmaceuticals, cosmetics, additives, fat, emulsions, fruit juices, liquors, oils, drinks...

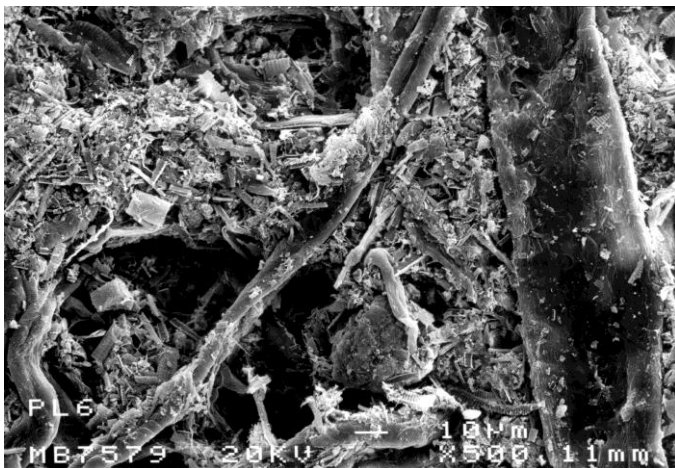

Description

The filtration of liquids through the use of filter presses and filter disks is nowadays a system that is still much in use for: industrial liquids, food, drinks, cosmetics. Filter sheets are made of pure cellulose and cotton fibers, Diatom soil, pearls and polyethylene fibers in some cases. This composition provides to this filtration method some interesting characteristics:

Excellent performance

The cellulose structure creates a three dimensional matrix due to the large void volume greater than 85%, allowing passage of high flow.

Retention

Auxiliary materials of the plates increase the retentive effect which, combined with the high positive zeta potential provide polyethylene fibers are retained, also causes small particles and negatively charged colloids.

Quality

The Filtros Anoya, S.A filter disks are manufactured according to the quality system DIN ISO 9001. All specific production parameters are monitored continuously during the whole manufacturing process.

Resistance

Thanks to the using inert polymers during the production process ensures that these plates are resistant to humid environments, even at concrete temperature.

APPLICATIONS

- Drinks: wine, grape juice, liquor, beer, cider, vinegar, mineral water, fruit juices, spirits, etc.
- Chemicals: resins, lacquers, stains, dyes, alcohols.
- Edible oils: olive, refined, seed, etc.
- Foodstuffs essences, syrups, additives, gelatine, fructose, glucose, vegetable extracts, etc.
- Pharmaceuticals: serum and plasma solutions, ophthalmic solutions, vaccines, etc.
- Cosmetics and perfumes: fragrances, scents, colognes.
- Hydrocarbons: gasoline, lubricants, mineral oils.



Technical specifications

Ref.	Effect	Grammage	Thickness	Density	Flow rate	Ash content	Nominal retention
		g/m ²	mm	g/cm ³	l/min x m ²	%	μm
PF-10	Breaker down	700 - 825	3.20 - 3.70	0.20 - 0.27	1250	< 2	40.0 - 50.0
PF-30	Breaker down	750 - 875	2.90 - 3.50	0.21 - 0.30	1110	17 - 21	7.0 - 11.0
PF-35	Breaker down	950 - 1075	3.50 - 3.70	0.26 - 0.31	950	22 - 27	4.0 - 7.0
PF-50	Clarifier	875 - 1000	2.10 - 2.30	0.38 - 0.48	235	30 - 37	3.0 - 4.0
PF-395	Medium polisher	1050 - 1200	3.40 - 3.70	0.28 - 0.35	600	37 - 43	3.5 - 5.5
PF-595	Medium polisher	1150 - 1300	3.40 - 3.70	0.31 - 0.38	200	36 - 42	2.0 - 3.0
PF-795	Fine polisher	1150 - 1300	3.40 - 3.60	0.32 - 0.38	120	38 - 44	1.0 - 2.25
PF-995	Sterile	1450 - 1600	3.50 - 4.00	0.36 - 0.46	55	36 - 42	0.4 - 0.6
PF-997	Sterile	1400 - 1600	3.60 - 4.10	0.34 - 0.44	67	44 - 50	0.25 - 0.45
PF-AC45	Active carbon 45%	1125 - 1250	3.85 - 4.35	0.18 - 0.19	440 - 765	n.a.	n.a.
PF-AC60	Active carbon 60%	1125 - 1250	3.85 - 4.35	0.18 - 0.19	440 - 765	n.a.	n.a.

Formats and dimensions



20 x 20	40 x 40	60 x 60
---------	---------	---------

Dimensions: Measures in cm

Presentation:
 20 x 20 cm: Cartons of 400 units
 40 x 40 cm: Cartons of 100 units
 60 x 60 cm: Cartons of 50 units

Other formats and dimensions available under demand.

INFORMATION FOR ORDERS. Filter sheets

Ref.	20 x 20 cm	40 x 40 cm	60 x 60 cm
PF-10	HJPF102020	HJPF104040	HJPF106060
PF-30	HJPF302020	HJPF304040	HJPF306060
PF-35	HJPF352020	HJPF354040	HJPF356060
PF-50	HJPF502020	HJPF504040	HJPF506060
PF-395	HJPF3952020	HJPF3954040	HJPF3956060
PF-595	HJPF5952020	HJPF5954040	HJPF5956060
PF-795	HJPF7952020	HJPF7954040	HJPF7956060
PF-995	HJPF9952020	HJPF9954040	HJPF9956060
PF-997	HJPF9972020	HJPF9974040	HJPF9976060
PF-AC45	HJPF-AC452020	HJPF-AC454040	HJPF-AC456060
PF-AC60	HJPF-AC602020	HJPF-AC604040	HJPF-AC606060

Filter press

Filtration of different industrial and pharmaceutical liquids, beverages, food, etc.



APPLICATIONS

- Filtration of wines, liqueurs, spirits, vinegar.
- Chemical filtration.
- Filtration of essential oils.
- Filtration of edible oils.
- Filtration of samples of high-volume laboratory.
- Small-scale production of perfumes

Description

Sometimes leakages must perform certain small volumes of liquids whose production is performed on a reduced scale (perfumes, pharmaceuticals, valuable liquids, etc.). In these cases require the use of filtration systems which are manageable, accurate and reliable.

FILTER-LAB® is a filtration system filter press for small size and portable. Use filter plates 20 x 20 cm, with a maximum of 36 plates. The version M3000 is made of bronze, and another quality M3000INOX, for food use is also made in bronze with the surface treatment steel.

It is available as an accessory gauge and spare parts: rubber washers, drip tray and filter holder plates.

Technical specifications

M3000 series equipment Material: brass body, PP plates, rubber washers
 Material M3000INOX team series: brass body with a surface treatment stainless steel, PP plates, rubber washers.
 Measure plates: 20 x 20 cm
 Maximum operating pressure: 20 bar
 Power supply: 220 V, 50 Hz
 Work Surface: 6 plates, 0.24 m², 12 plates, 0.48 m², 18 plates, 0.72 m², 36 plates, 1.44 m²
 Weight: 17 kg (6 plates)
 Dimensions: 450 x 270 x 280 mm
 Input / Output: rubber tube 20 mm diameter

INFORMATION FOR ORDERS. Plat filter press

M3000

plates	Cod.
6	M30002020-6
12	M30002020-12
18	M30002020-18
36	M30002020-36

M3000 INOX

plates	Cod.
6	M3000INOX2020-6
12	M3000INOX2020-12
18	M3000INOX2020-18
36	M3000INOX2020-36

ACCESORIES

Cod.	Description
M3000-V1	Pressure-gauge and regulation valve
	Adaptable to all kind of filter press
M3000-AG	Gum washer. Bag of 8 units
M3000-BG	Drippin tray
M3000-PB	White filter holder plate
M3000-PRE	Red filter holder plate input
M3000-PRS	Red filter holder plate output

MEMBRANE FILTERS GUIDE FILTER-LAB®

MEMBRANE MATERIAL	PORE SIZE (µm)	DIAMETER	FORMATS	COLOR	SURFACE	WETTABILITY
Celulosa acetate	0.22	13	non sterile	white	smooth	hydrophylic
	0.45	25				
	0.8	47				
	3.0	90				
	5.0	142				
		293				
Mixed cellulose esters (MCE)	0.22	13	sterile	white	gridded	hydrophylic
	0.45	25	non sterile	black	smooth	
	0.65	47				
	1.0	90				
	3.0	142				
	5.0	293				
	8.0					
Celulose nitrate (CN) (Rollos)	0.2	47	sterile	white	gridded	hydrophylic
	0.45	50		black		
	0.65			green		
	0.8					
	1.2					
Polyamide (Nylon)	0.22	13	non sterile	white	smooth	hydrophylic
	0.45	25				
	5.0	47				
		90				
		142				
		293				
Polyethersulphone (PES)	0.1	25	non sterile	white	smooth	hydrophylic
	0.22	47				
	0.45					
Polivinildifluorure (PVDF)	0.22	25	non sterile	white	smooth	hydrophobic
	0.45	47				
Polytetrafluorure ehtylene (PTFE)	0.22	13	non sterile	white	smooth	hydrophobic
	0.45	25				
	1.2	47				
	5.0	90				
		142				
	293					
Polypropilene (PP)	0.22	25	non sterile	white	smooth	hydrophobic
	0.45	47				
Polycarbonate (PC)	0.1	13	non sterile	white	smooth	hydrophylic
	0.2	25	sterile			
	0.4	47				
	0.8					
	2.0					
	3.0					
	5.0					
	8.0					
	12.0					
	14.0					
	20.0					
Regenerated cellulose (RC)	0.22	25	non sterile	white	smooth	hydrophylic
	0.45	47				
Polyester (PE)	0.2	25	non sterile	translucent	smooth	hydrophylic
	0.45	47				

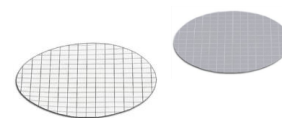

MAX. TEMPERATURE	CHEMICAL COMPATIBILITY pH	PROTEIN ABSORPTION	STERILIZATION	PAGE
≤ 50°C	4 - 8 Aqueous samples Biological samples Alcohols Oils Hidrocarbons	Very low	Radiación γ Óxido de etileno Autoclave a 121°C Calor seco	84
≤ 50°C	4 - 8 Aqueous samples	High	Radiation γ Ethylene oxide Autoclaving to 121°C	86
≤ 130°C	4 - 8 Aqueous samples	High	Radiation γ Ethylene oxide Autoclaving to 121°C	92
≤ 100°C	3 - 14 Alcaline solutions Soft organic samples	High	Radiation γ Ethylene oxide Autoclaving to 121°C	94
≤ 90°C	1 - 14 Biological samples Solvents	Very low	Radiation γ Ethylene oxide Autoclaving to 121°C	96
≤ 100°C	1 - 14 Strong solvents	Very low	Radiation γ Autoclaving to 121°C	102
≤ 130°C	1 - 14 Agresive solvents	Very low	Radiation γ Ethylene oxide Autoclaving to 121°C	98
≤ 50°C	1 - 14	No	Radiación γ Autoclave a 121°C	100
≤ 140°C	4 - 8 Biological samples Aqueous samples	Low	Autoclaving to 121°C	104
≤ 180°C	3 - 12	Low	Radiation γ , autoclaving heat dry, ethylene oxide	106
≤ 130°C	1 - 14	Low	Radiation γ Ethylene oxide	108

Cellulose acetate membrane filter

Low absorption of proteins for filtration of biological and aqueous samples

Description

Cellulose acetate is a hydrophilic material and with very low nonspecific adsorption of proteins. These characteristics make it suitable membrane filtration in the case of biological samples.

It is also recommended for use in the filtration of aqueous samples, most alcohols, oils and hydrocarbons.

It is available in pores of 0.22 to 5.0 microns and diameters from 13 to 293 mm in diameter.



Advantages

- Hydrophilic nature.
- Extremely low nonspecific adsorption of proteins.
- Very uniform pore structure.
- Good thermal and mechanical resistance.
- Autoclave at 121°C
- Made free static charge.

Applications

- Sterilization of samples with proteins and enzymes.
- Sterilization of biological fluids.
- Sterilization of culture media.
- Recovery of gram negative organisms.
- Filtration of aqueous samples.

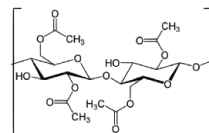

TECHNICAL SPECIFICATIONS

Bubble point with water (minimum value)

0.22 μm	4.0 bar 400 Kpa
0.45 μm	3.1 bar 310 Kpa
0.8 μm	1.5 bar 150 Kpa
3.0 μm	0.5 bar 50 Kpa
5.0 μm	0.4 bar 40 Kpa

Flow rate with water (ml/min /cm²)|p=0.9bar | 90 Kpa aprox.:

0.22 μm	18,5 ml/min/cm ²
0.45 μm	40 ml/min/cm ²
0.8 μm	150 ml/min/cm ²
3.0 μm	500 ml/min/cm ²
5.0 μm	900 ml/min/cm ²

Flow rate with air (ml/min /cm²):

0.22 μm	-
0.45 μm	25 ml/min/cm ²
0.8 μm	50 ml/min/cm ²
3.0 μm	180 ml/min/cm ²
5.0 μm	280 ml/min/cm ²

Thickness: 0.115– 0.140 mm

Membrane material

Diacetate and triacetate cellulose

Pore sizes: 0.22, 0.45, 0.8, 3.0 and 5.0 μm

Diameters: 13, 25, 47, 90, 142 y 293 mm.

Maximum temperature of use ≤ 50°C

Maximum pressure of work: 8.7 psi

Extractables with water < 0.1%

Chemical compatibility: 4 – 8 pH

Reaction to water: hydrophilic

Absorption: Low absorption non specific in proteins.

Sterilization: Autoclave at 121°C ó 134°C, γ radiation, dry hot at 134°C, ethylene oxide

INFORMATION FOR ORDERS. Cellulose acetate membrane filters

	Código	Membrane material	Diameter	Pore size	Color	Surface	Format	Quantity
13 mm Ø	MCA022013N	Cellulose acetate	13 mm	0.22 µm	white	smooth	non sterile	100 units
	MCA045013N	Cellulose acetate	13 mm	0.45 µm	white	smooth	non sterile	100 units
	MCA080013N	Cellulose acetate	13 mm	0.8 µm	white	smooth	non sterile	100 units
	MCA300013N	Cellulose acetate	13 mm	3.0 µm	white	smooth	non sterile	100 units
	MCA500013N	Cellulose acetate	13 mm	5.0 µm	white	smooth	non sterile	100 units
25 mm Ø	MCA022025N	Cellulose acetate	25 mm	0.22 µm	white	smooth	non sterile	100 units
	MCA045025N	Cellulose acetate	25 mm	0.45 µm	white	smooth	non sterile	100 units
	MCA080025N	Cellulose acetate	25 mm	0.8 µm	white	smooth	non sterile	100 units
	MCA300025N	Cellulose acetate	25 mm	3.0 µm	white	smooth	non sterile	100 units
	MCA500025N	Cellulose acetate	25 mm	5.0 µm	white	smooth	non sterile	100 units
47 mm Ø	MCA022047N	Cellulose acetate	47 mm	0.22 µm	white	smooth	non sterile	100 units
	MCA045047N	Cellulose acetate	47 mm	0.45 µm	white	smooth	non sterile	100 units
	MCA080047N	Cellulose acetate	47 mm	0.8 µm	white	smooth	non sterile	100 units
	MCA300047N	Cellulose acetate	47 mm	3.0 µm	white	smooth	non sterile	100 units
	MCA500047N	Cellulose acetate	47 mm	5.0 µm	white	smooth	non sterile	100 units
90 mm Ø	MCA022090N	Cellulose acetate	90 mm	0.22 µm	white	smooth	non sterile	100 units
	MCA045090N	Cellulose acetate	90 mm	0.45 µm	white	smooth	non sterile	100 units
	MCA080090N	Cellulose acetate	90 mm	0.8 µm	white	smooth	non sterile	100 units
	MCA300090N	Cellulose acetate	90 mm	3.0 µm	white	smooth	non sterile	100 units
	MCA500090N	Cellulose acetate	90 mm	5.0 µm	white	smooth	non sterile	100 units
142 mm Ø	MCA022142G	Cellulose acetate	142 mm	0.22 µm	white	smooth	non sterile	25 units.
	MCA045142G	Cellulose acetate	142 mm	0.45 µm	white	smooth	non sterile	25 units.
	MCA080142G	Cellulose acetate	142 mm	0.8 µm	white	smooth	non sterile	25 units.
	MCA300142G	Cellulose acetate	142 mm	3.0 µm	white	smooth	non sterile	25 units.
	MCA500142G	Cellulose acetate	142 mm	5.0 µm	white	smooth	non sterile	25 units.
293 mm Ø	MCA022293G	Cellulose acetate	293 mm	0.22 µm	white	smooth	non sterile	25 units.
	MCA045293G	Cellulose acetate	293 mm	0.45 µm	white	smooth	non sterile	25 units.
	MCA080293G	Cellulose acetate	293 mm	0.8 µm	white	smooth	non sterile	25 units.
	MCA300293G	Cellulose acetate	293 mm	3.0 µm	white	smooth	non sterile	25 units.
	MCA500293G	Cellulose acetate	293 mm	5.0 µm	white	smooth	non sterile	25 units.

Membrane filters: Mixed cellulose esters (MCE)

Filtration of aqueous samples, studies of particles, microbiological analyses.

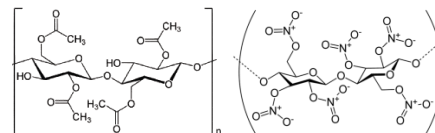

Description

Membrane filters made of a mixture of cellulose nitrate and cellulose acetate, a totally inert.

These membranes are characterized by a more uniform and smooth surface to the nitrocellulose, which makes it widely used in microbiological analysis, particle studies, chemotaxis, etc.

They are available in a wide range of pore diameters, sterile and non-sterile form, and even with the surface grid with grids of 3.1 mm² for use in the colony count.

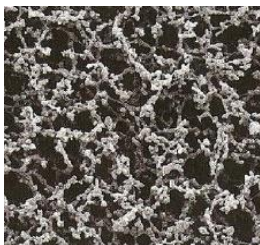

Advantages

- Hydrophilic nature
- Membrane surface very uniform
- High porosity
- Pore structure, very regular
- Wide range of pore diameters and formats.
- Very high purity: free of newt.
- Biologically inert.

Applications

0.22 μm

- Sample Sterilization
- Microbiological analyses
- Biological assays
- Legionella analysis according to ISO 11731 part II

0.45 μm

- Clarification of aqueous samples
- Retention and particle analysis
- Microbiological analysis
- Fluorescence Assays
- Particle monitoring

0.65 μm

- Determination of sedimentation
- Retention of microorganisms and algae.

0.8 μm

- Determination of media contamination in hydrocarbon distillates according to EN 12662

1.0 μm

- Clarification of aqueous samples
- Air analysis
- Fluorescence assays

3.0 μm

- Retention and particle analysis
- Quality control of fluids

5.0 μm

- Retention and particle analysis
- Quality control of fluids

8.0 μm

- Retention and particle analysis
- Pre-filtration of samples



TECHNICAL SPECIFICATIONS

Bubble point with water (minimum value)

0.22 µm	3.62 bar 362 Kpa
0.45 µm blanca	2.23 bar 223 Kpa
0.45 µm negra	2.35 bar 235 Kpa
0.65 µm	1.18 bar 118 Kpa
0.8 µm	0.95 bar 95 Kpa
1.0 µm	0.77 bar 77 Kpa
3.0 µm	0.69 bar 69 Kpa
5.0 µm	0.56 bar 56 Kpa
8.0 µm	0.40 bar 40 Kpa

Flow rate with water (ml/min /cm²)Δp=0.7 bar | 70 Kpa aprox.:

0.22 µm	19 ml/min/cm ²
0.45 µm blanca	60 ml/min/cm ²
0.45 µm negra	60 ml/min/cm ²
0.65 µm	135 ml/min/cm ²
0.8 µm	180 ml/min/cm ²
1.0µm	270 ml/min/cm ²
3.0 µm	320 ml/min/cm ²
5.0 µm	560 ml/min/cm ²
8.0 µm	600 ml/min/cm ²

Flow rate with air (ml/min /cm²):

0.22 µm	2 ml/min/cm ²
0.45 µm	5 ml/min/cm ²
0.65 µm	9 ml/min/cm ²
0.8 µm	15 ml/min/cm ²
1.0µm	20 ml/min/cm ²
3.0 µm	28 ml/min/cm ²
5.0 µm	30 ml/min/cm ²
8.0 µm	63 ml/min/cm ²

Porosity

0.22 µm	75%
0.45 µm	79%
0.65 µm	81%
0.8 µm	82%
1.0µm	82%
3.0 µm	83%
5.0 µm	84%
8.0 µm	84%

Thickness: 0.100 – 0.150 mm

Material

Mixed cellulose esters

Diameters: 13, 25, 47, 90, 142 and 293 mm.

Maximum temperature ≤ 90°C

Maximum pressure: 8.7 psi

Extractables with water < 0.2%

Chemical compatibility: 4 – 8 pH

Reaction to the water: hydrophilic

Adsorption: Low non specific protein absorption

Esterilization: No



INFORMATION FOR ORDERS. Cellulose mixed esters membrane filters

WHITE, SMOOTH, NON STERILE

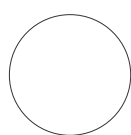

	Code	Membrane material	Diameter	Ppore size	Color	Surface	Format	Quantity
13 mm ϕ	MCE022013N	Cel. mixed esters	13 mm	0.22 μ m	white	smooth	non sterile	100 units
	MCE045013N	Cel. mixed esters	13 mm	0.45 μ m	white	smooth	non sterile	100 units
	MCE065013N	Cel. mixed esters	13 mm	0.65 μ m	white	smooth	non sterile	100 units
	MCE080013N	Cel. mixed esters	13 mm	0.8 μ m	white	smooth	non sterile	100 units
	MCE100013N	Cel. mixed esters	13 mm	1.0 μ m	white	smooth	non sterile	100 units
	MCE300013N	Cel. mixed esters	13 mm	3.0 μ m	white	smooth	non sterile	100 units
	MCE500013N	Cel. mixed esters	13 mm	5.0 μ m	white	smooth	non sterile	100 units
	MCE800013N	Cel. mixed esters	13 mm	8.0 μ m	white	smooth	non sterile	100 units
25 mm ϕ	MCE022025N	Cel. mixed esters	25 mm	0.22 μ m	white	smooth	non sterile	100 units
	MCE045025N	Cel. mixed esters	25 mm	0.45 μ m	white	smooth	non sterile	100 units
	MCE065025N	Cel. mixed esters	25 mm	0.65 μ m	white	smooth	non sterile	100 units
	MCE080025N	Cel. mixed esters	25 mm	0.8 μ m	white	smooth	non sterile	100 units
	MCE100025N	Cel. mixed esters	25 mm	1.0 μ m	white	smooth	non sterile	100 units
	MCE300025N	Cel. mixed esters	25 mm	3.0 μ m	white	smooth	non sterile	100 units
	MCE500025N	Cel. mixed esters	25 mm	5.0 μ m	white	smooth	non sterile	100 units
	MCE800025N	Cel. mixed esters	25 mm	8.0 μ m	white	smooth	non sterile	100 units
37 mm ϕ	MCE022037N	Cel. mixed esters	37 mm	0.22 μ m	white	smooth	non sterile	100 units
	MCE045037N	Cel. mixed esters	37 mm	0.45 μ m	white	smooth	non sterile	100 units
	MCE100037N	Cel. mixed esters	37 mm	1.0 μ m	white	smooth	non sterile	100 units
47 mm ϕ	MCE022047N	Cel. mixed esters	47 mm	0.22 μ m	white	smooth	non sterile	100 units
	MCE045047N	Cel. mixed esters	47 mm	0.45 μ m	white	smooth	non sterile	100 units
	MCE065047N	Cel. mixed esters	47 mm	0.65 μ m	white	smooth	non sterile	100 units
	MCE080047N	Cel. mixed esters	47 mm	0.8 μ m	white	smooth	non sterile	100 units
	MCE100047N	Cel. mixed esters	47 mm	1.0 μ m	white	smooth	non sterile	100 units
	MCE300047N	Cel. mixed esters	47 mm	3.0 μ m	white	smooth	non sterile	100 units
	MCE500047N	Cel. mixed esters	47 mm	5.0 μ m	white	smooth	non sterile	100 units
	MCE800047N	Cel. mixed esters	47 mm	8.0 μ m	white	smooth	non sterile	100 units
90 mm ϕ	MCE022090N	Cel. mixed esters	90 mm	0.22 μ m	white	smooth	non sterile	100 units
	MCE045090N	Cel. mixed esters	90 mm	0.45 μ m	white	smooth	non sterile	100 units
	MCE065090N	Cel. mixed esters	90 mm	0.65 μ m	white	smooth	non sterile	100 units
	MCE080090N	Cel. mixed esters	90 mm	0.8 μ m	white	smooth	non sterile	100 units
	MCE100090N	Cel. mixed esters	90 mm	1.0 μ m	white	smooth	non sterile	100 units
	MCE300090N	Cel. mixed esters	90 mm	3.0 μ m	white	smooth	non sterile	100 units
	MCE500090N	Cel. mixed esters	90 mm	5.0 μ m	white	smooth	non sterile	100 units
	MCE800090N	Cel. mixed esters	90 mm	8.0 μ m	white	smooth	non sterile	100 units
142 mm ϕ	MCE022142G	Cel. mixed esters	142 mm	0.22 μ m	white	smooth	non sterile	25 units
	MCE045142G	Cel. mixed esters	142 mm	0.45 μ m	white	smooth	non sterile	25 units
	MCE065142G	Cel. mixed esters	142 mm	0.65 μ m	white	smooth	non sterile	25 units
	MCE080142G	Cel. mixed esters	142 mm	0.8 μ m	white	smooth	non sterile	25 units
	MCE100142G	Cel. mixed esters	142 mm	1.0 μ m	white	smooth	non sterile	25 units
	MCE300142G	Cel. mixed esters	142 mm	3.0 μ m	white	smooth	non sterile	25 units
	MCE500142G	Cel. mixed esters	142 mm	5.0 μ m	white	smooth	non sterile	25 units
	MCE800142G	Cel. mixed esters	142 mm	8.0 μ m	white	smooth	non sterile	25 units

INFORMATION FOR ORDERS. Cellulose mixed esters membrane filters

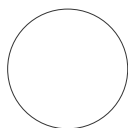

WHITE, SMOOTH, NON STERILE

	Code	Membrane material	Diameter	Pore size	Color	Surface	Format	Quantity
293 mm \varnothing	MCE022293G	Mixed cel. Esters	293 mm	0.22 μ m	white	smooth	non sterile	25 units
	MCE045293G	Mixed cel. Esters	293 mm	0.45 μ m	white	smooth	non sterile	25 units
	MCE065293G	Mixed cel. Esters	293 mm	0.65 μ m	white	smooth	non sterile	25 units
	MCE080293G	Mixed cel. Esters	293 mm	0.8 μ m	white	smooth	non sterile	25 units
	MCE100293G	Mixed cel. Esters	293 mm	1.0 μ m	white	smooth	non sterile	25 units
	MCE300293G	Mixed cel. Esters	293 mm	3.0 μ m	white	smooth	non sterile	25 units
	MCE500293G	Mixed cel. Esters	293 mm	5.0 μ m	white	smooth	non sterile	25 units
	MCE800293G	Mixed cel. Esters	293 mm	8.0 μ m	white	smooth	non sterile	25 units

WHITE, GRIDDED, STERILE

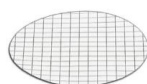

	Code	Membrane material	Diameter	Pore size	Color	Surface	Format	Quantity
47 mm	MCE022047WGSN	Mixed cel. Esters	47 mm	0.22 μ m	white	gridded	sterile	100 units
	MCE045047WGSN	Mixed cel. Esters	47 mm	0.45 μ m	white	gridded	sterile	100 units

BLACK, GRIDDED, STERILE



	Código	Membrane material	Diameter	Pore size	Color	Surface	Format	Quantity
47 mm	MCE022047BGSN	Mixed cel. Esters	47 mm	0.22 μ m	black	gridded	sterile	100 units
	MCE045047BGSN	Mixed cel. Esters	47 mm	0.45 μ m	black	gridded	sterile	100 units

Blotting membranes FILTER-LAB® TM

Protein transfer according to various techniques in biotechnology laboratories

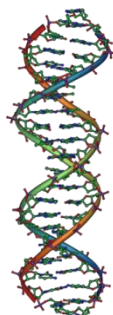

Description

Blotting membranes by FILTER-LAB® commonly used in biotechnology protein transfer techniques, western, dot and dot slot, traditional transfer DNA and RNA, nucleic acid detection, northerns and southern.

This family consists of membranes of different materials: polyvinylidene fluoride (PVDF), nitrocellulose and polyamide (nylon). Supplied in rolls of 300 mm width and a length of 3 meters, and in sheets of 20 x 20 cm.

Technical parameters	TM NITRO		TM PVDF		TM NYLON	
	0.22 µm	0.45 µm	0.22 µm	0.45 µm	0.22 µm	0.45 µm
Bubble point (kg/cm ² a 10 psi)	3.65	2.11	-	-	3.51	2.11
Flow rate (mls/min/cm ² a 10 psi)	19	51	-	-	9.9	27
Thickness (µm)	150±10	150±10	40-250	40-250	65-125	65-125
Extractables (%)	< 4	< 4	-	-	< 0.2	< 0.2
Protein captation (µg/cm ² BSA)	160	160	125	125	350	350
Maximum temperature (°C)	56	56	-	-	180	180

Formats and dimensions



20 x 20

Dimensions: size in cm
Presentation: Depending on sheets size



30 x 300

Dimensions: Width in cm x length in cm
Presentation: Unit

INFORMATION FOR ORDERS. Transfer membranes FILTER-LAB® TM

Membrane material	Pore µm	Format	Size: width x length (cm)	units/pack	Cod.
Nitrocellulose	0.22	Sheets	20 x 20	10	TMNC0222020
Nitrocellulose	0.22	Roll	30 x 300	1	TMBNC022/30300
Nitrocellulose	0.45	Sheets	20 x 20	10	TMNC0452020
Nitrocellulose	0.45	Roll	30 x 300	1	TMBNC045/30300
PVDF	0.22	Sheets	20 x 20	10	TMPV0222020
PVDF	0.22	Roll	30 x 300	1	TMBPV022/30300
PVDF	0.45	Sheets	20 x 20	10	TMPV0452020
PVDF	0.45	Roll	30 x 300	1	TMBPV045/30300
Nylon	0.22	Sheets	20 x 20	10	TMNY0222020
Nylon	0.22	Roll	30 x 300	1	TMBNY022/30300
Nylon	0.45	Sheets	20 x 20	10	TMNY0452020
Nylon	0.45	Roll	30 x 300	1	TMBNY045/30300

APPLICATIONS

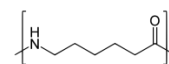
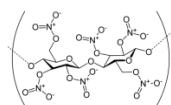

	TM Nitro	TM PVDF	TM Nylon
Description	One of the membranes more used in analysis and investigations applications. It minimizes the quantity of the moisturizer agent and has an extractables level very low	This PVDF membrane has a high adsorption, therefore they won't be lost during the transfer. It's open pore structure	Its open pore structure permit the sequence accesibility. Ideal for low-load applications
Composition	100% pure nitrocellulose	100% Polyvinylidene fluoride	100% Nylon 6
Applications	<ul style="list-style-type: none"> Nucleic acid and protein transfer Westerns blotting Southern blotting Northern blotting Multiple hybridizations 	<ul style="list-style-type: none"> Westerns blotting Binding assays Amino acid analysis Protein sequencing Dot slot transfer Glycoproteins display Alipopolsaccharides analysis 	<ul style="list-style-type: none"> Dot slot transfer Clarification of aqueous samples Cell cultures Transfer of plates and colonies
Detection methods	<ul style="list-style-type: none"> Fluorescence Radiolabelling Chromogenic detection 	<ul style="list-style-type: none"> Enzyme antibody conjugates Chromogenic detection Chemiluminiscence Direct stain 	<ul style="list-style-type: none"> Fluorescence Radiolabelling Chromogenic detection
Dye compatibility	<ul style="list-style-type: none"> Amido black India ink Ponceau-S red Colloidal gold CPTS 	<ul style="list-style-type: none"> Coomasie brilliant blue Amido black India ink Ponceau-S red Colloidal gold CPTS Toluidine blue Transillumination Sypro® ruby 	<ul style="list-style-type: none"> Amido black India ink Ponceau-S red Colloidal gold CPTS
Advantage	<ul style="list-style-type: none"> Excellent mechanic resistance Manufactured without support Without detergent added 100% pure nitrocellulose Good absorption properties 	<ul style="list-style-type: none"> Good chemical resistance No discoloration Non flamable Excellent mechanic resistance Efficient capture of proteins 	<ul style="list-style-type: none"> Good chemical resistance Excellent mechanic resistance Good absorption properties High sensibility
Properties	<ul style="list-style-type: none"> Hydrophobic Electrostatic 	<ul style="list-style-type: none"> Hydrophobic 	<ul style="list-style-type: none"> Hydrophobic
Inmobilization method	UV Crossling Baking (vacuum furnace)	Electroblotting	UV Crossling Baking

Membrane filter dispenser

Filtration of watery samples, study of particles, microbiological analysis

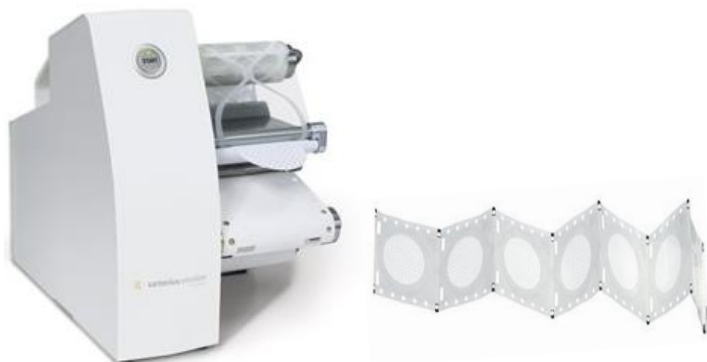

Description

Automatic dispenser cellulose nitrate membranes in roll sterile individual. The device dispenses a membrane filter when the button is pressed analyst or when the optical sensor detects the presence of the grippers when approaching take a membrane. The compact design makes it easy to handle and easy to clean.

Microsart® membrane filters are in rolls of a resilient plastic material which ensures total protection and sterility. Furthermore, to ensure traceability of the membranes, supplied with the lot number, the diameter and the serial number printed on the plastic wrap on each individual blister.

Microsart® membrane filters are available in pore 0.2, 0.45, 0.65, 0.8 and 1.2 microns.

Furthermore, Sartorius has developed High Flow membranes of 0.2 and 0.45 microns. Its main feature is a high filtration rate thanks to the special structure of the pores.

Manufactured in 47 and 50 mm in diameter, squared and white, green and gray. sterilized by γ radiation

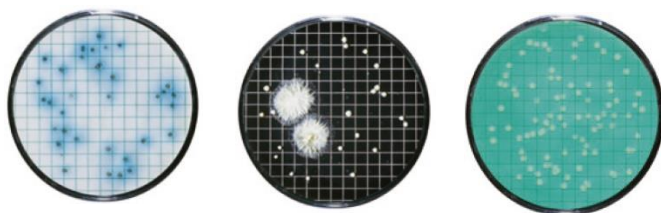

Performance levels for some pore diameters

Pore size	0.2 μm^*	0.45 μm^{**}	0.45 μm high flow	0.65 μm
Flow rate with water per cm^2 at 1 bar according DIN 58355 (ml/min)	20	70	100	130
Coliforms retention (%)	100	100	100	no test
Type of recuperation according to ISO 7704 as a criteria of lot liberation (%)	≤ 90	≤ 90	≤ 90	≤ 90

*) Pore size determined by quantitative retention of Brevundimonas according to ASTM document F 838-83 (1993) Standard test method for determination of bacterial retention of membrane filters used for the filtration of liquids

***) Poro size determined for the quantitative retention of Serratia marcescens according to Standard Methods for water and wastewater

TECHNICAL SPECIFICATIONS. Microsart e.motion dispenser

Dimensions: 204 x 213 x 165 mm

Weight: 2.9 kg

Voltage: 110 V/230 V optional

Frequency: 50 – 60 Hz

Maximum power: 10 W

Dispensation velocity: 0.5 s

Dispensation interval: 5 s

Applied regulation:

Label CE y directive EMC
European Standard EN 50081-1 and -2
EN 50082 and EN 61010

TECHNICAL SPECIFICATIONS Microsart membranes

Diameters: 47 or 50 mm

Colors: white, green and grey.

Pores: 0.2 μm , 0.2 μm high flow, 0.45 μm , 0.45 μm high flow, 0.65 μm , 0.8 μm , 1.2 μm

Square dimensions: 3.1 x 3.1 mm (130 squared)

Sterilization: γ -radiation

Thermal radiation: 130°C

Chemical compatibility: aqueous solutions (pH 4-8), hydrocarbures and other organic solvents (see chemical compatibility table of membrane)

INFORMATION FOR ORDERS. Dispenser and Microsart® membranes

Membrane dispenser and accessory

Code	Description
16712	Automatic membrane dispenser
1ZE-0028	Dispenser pedal

Cellulose nitrate membranes in roll

	Code	Membrane material	Diameter	Pore size	Color	Grid	Format	Presentation*
0.2 µm	11407Z-47SCM	Cellulose nitrate	47 mm.	0.2 µm	white	black	sterile	300 units/pack
	11407Z-50SCM	Cellulose nitrate	50 mm.	0.2 µm	white	black	sterile	300 units/pack
0.45 µm	11406Z-47SCM	Cellulose nitrate	47 mm.	0.45 µm	white	black	sterile	300 units/pack
	114H6Z-47SCM	Cellulose nitrate	47 mm.	0.45 µm high flow	white	black	sterile	300 units/pack
	11406Z-50SCM	Cellulose nitrate	50 mm.	0.45 µm	white	black	sterile	300 units/pack
	139H6Z-47SCM	Cellulose nitrate	47 mm.	0.45 µm high flow	white	green	sterile	300 units/pack
	13906Z-47SCM	Cellulose nitrate	47 mm.	0.45 µm	white	green	sterile	300 units/pack
	13906Z-50SCM	Cellulose nitrate	50 mm.	0.45 µm	white	green	sterile	300 units/pack
	13006Z-47SCM	Cellulose nitrate	47 mm.	0.45 µm	grey	white	sterile	300 units/pack
	13006Z-50SCM	Cellulose nitrate	50 mm.	0.45 µm	grey	white	sterile	300 units/pack
	130H6Z-50SCM	Cellulose nitrate	50 mm.	0.45 µm high flow	grey	white	sterile	300 units/pack
	13806Z-47SCM	Cellulose nitrate	47 mm.	0.45 µm	green	dark green	sterile	300 units/pack
	13806Z-50SCM	Cellulose nitrate	50 mm.	0.45 µm	green	dark green	sterile	300 units/pack
	0.65 µm	13005Z-47SCM	Cellulose nitrate	47 mm.	0.65 µm	grey	white	sterile
13005Z-50SCM		Cellulose nitrate	50 mm.	0.65 µm	grey	white	sterile	300 units/pack
0.8 µm	13004Z-47SCM	Cellulose nitrate	47 mm.	0.8 µm	grey	white	sterile	300 units/pack
	13005Z-50SCM	Cellulose nitrate	50 mm.	0.8 µm	grey	white	sterile	300 units/pack
1.2 µm	11403Z-47SCM	Cellulose nitrate	47 mm.	1.2 µm	white	black	sterile	300 units/pack
	11403Z-50SCM	Cellulose nitrate	50 mm.	1.2 µm	white	black	sterile	300 units/pack

* 3 rolls of 100 units each one

Polyamide membrane filters (nylon)

Filtration of samples for HPLC, aqueous samples, alcoholic solutions and solvents

Description

Membrane filters hydrophilic nature, flexible and resistant. Especially suitable particle uptake and general medical applications filtrations with organic solvents and aqueous samples.

This membrane has high specific protein adsorption and good resistance to alkaline solutions.

It is available in pore 0.22, 0.45 and 5.0 microns, and diameters 13, 25, 47, 90, 142 and 293 mm.

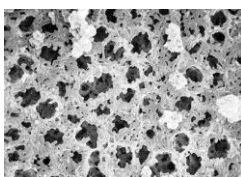

Advantages

- Hydrophilic.
- Low extractable level.
- High absorption of proteins.
- Excellent physical and thermal resistance.
- Good compatibility with aqueous samples, alkalis and organic solvents.
- Sterilization in autoclaving.

Applications

- Retention of bacteria and particles.
- Filtration of samples and solvents in HPLC.
- Diagnostic Kits.
- Biosensors.
- Analysis of Blood Glucose.
- Drugs filtration.
- Determination of the presence of Legionella in water samples according to ISO 11731 part I.
- Recovery of specific size particles.

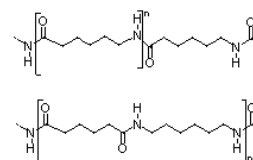

TECHNICAL SPECIFICATIONS

Bubble point with water (minimum value)

0.22 μm	≥ 3.4 bar 340 Kpa
0.45 μm	≥ 2.0 bar 200 Kpa
5.0 μm	≥ 0.41 bar 41 Kpa

Flow rate with water (ml/min /cm²) Δp=0.7 bar | 70 Kpa aprox.:

0.22 μm	9.9 ml/min/cm ²
0.45 μm	26.9 ml/min/cm ²
5.0 μm	331 ml/min/cm ²

Flow rate with air (ml/min /cm²) Δp=0.7 bar | 70 Kpa aprox.:

0.22 μm	1.7 ml/min/cm ²
0.45 μm	3.2 ml/min/cm ²
5.0 μm	36 ml/min/cm ²

Thickness: 0.100 – 0.120 mm

Membrane material

Polyamide 66 (nylon)

Diameters: 13, 25, 47, 90, 142 and 293 mm.

Maximum temperature of use ≤ 180°C

Maximum pressure of work: 8.7 psi

Extractables with water < 0.2%

Chemical compatibility: 3– 14 pH

Reaction to water: hydrophilic

Absorption: High absorption non-specified of proteins

Sterilization: Autoclave at 121°C ó 134°C, radiation γ, dry hot at 134°C, ethylene oxide

INFORMATION FOR ORDERS. Polyamide membrane filter (nylon)

	Code	Membrane material	Diameter	Pore size	Color	Surface	Format	Quantity
13 mm	MNY022013N	Nylon	13 mm	0.22 µm	white	smooth	non sterile	100 units
	MNY045013N	Nylon	13 mm	5.0 µm	white	smooth	non sterile	100 units
25 mm	MNY022025N	Nylon	25 mm	0.22 µm	white	smooth	non sterile	100 units
	MNY045025N	Nylon	25 mm	5.0 µm	white	smooth	non sterile	100 units
47 mm Ø	MNY022047N	Nylon	47 mm	0.22 µm	white	smooth	non sterile	100 units
	MNY045047N	Nylon	47 mm	0.45 µm	white	smooth	non sterile	100 units
	MNY500047N	Nylon	47 mm	5.0 µm	white	smooth	non sterile	100 units
90 mm	MNY022090N	Nylon	90 mm	0,22 µm	white	smooth	non sterile	100 units
	MNY045090N	Nylon	90 mm	0.45 µm	white	smooth	non sterile	100 units
142 mm	MNY022142G	Nylon	142 mm	0.22 µm	white	smooth	non sterile	25 units
	MNY045142G	Nylon	142 mm	5.0 µm	white	smooth	non sterile	25 units
293 mm	MNY022293G	Nylon	293 mm	0.22 µm	white	smooth	non sterile	25 units
	MNY045293G	Nylon	293 mm	5.0 µm	white	smooth	non sterile	25 units

Polyethersulphone membrane filters (PES)

Filtration of aqueous samples, biological samples and also some solvents

Description

The polyethersulphone is a material with excellent qualities: it is hydrophilic, has excellent flow rate and high particle loading capacity, high thermal stability, (low nonspecific adsorption and supported by some aggressive solvents).

Is mainly used in filtration of biological samples, aqueous or solvent solutions (see compatibility).

Supplied in pores of 0.1, 0.22 and 0.45 microns, and in 25 and 47 mm diameter.

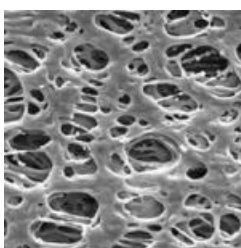

Advantages

- Hydrophilic
- Low removable
- High load
- Lower protein adsorption
- Excellent thermal resistance
- Good compatibility with aqueous samples and some aggressive solvents.
- Autoclave at 121 ° C
- Available in 0.1 um pore size

Applications

- Filtration of water samples.
- Filtration of high temperature fluids.
- Filtration of chemical reagents.
- Ultra-cleanliness solutions (0.1 microns)
- Sterilization of biological samples, serum, drugs, culture media, protein samples, etc.

TECHNICAL SPECIFICATIONS

Bubble point with water (minimum value)

0.1 μm	2.1 bar 210 Kpa
0.22 μm	3.4 bar 340 Kpa
0.45 μm	2.7 bar 270 Kpa

Flow rate with water (s/100 ml H₂O/9.62 cm² to 24 in Hg):

0.1 μm	≤ 130
0.22 μm	≤ 30
0.45 μm	≤ 21

Burst resistance (≤ N psi):

0.1 μm	18
0.22 μm	16
0.45 μm	16

Thickness: 0.120 – 0.150 mm

Habitual weight in grams: 3.0 mg/cm²

Membrane material

Polyethersulphone (PES)

Diameters: 25 and 47 mm.

Pore sizes: 0.1, 0.2 and 0.45 μm

Maximum temperature of use ≤ 121°C (30 min)

Extractables with water < 1% (< 0.015 mg/cm²)

Sterilization: Using γ irradiation, ethylene oxide, autoclaving or vapor at 121°C

Chemical compatibility: 1– 14 pH

Reaction to water: hydrophilic

Absorption of proteins BSA: < 20 μg/cm²

Levels of endotoxins: < 0.25 Eu/ml using 400 cm²/400 ml S.W.F.I. for the test with Limulus Amoebocyte Lysate (LAL)

INFORMATION FOR ORDERS. Polyethersulfone membrane filters (PES)

	Code	Membrane material	Diameter	Pore size	Color	Surface	Format	Quantity
25 mm \varnothing	MPES010025N	Polietersulfona (PES)	25 mm	0.1 μm	white	smooth	non sterile	100 units
	MPES022025N	Polietersulfona (PES)	25 mm	0.22 μm	white	smooth	non sterile	100 units
	MPES045025N	Polietersulfona (PES)	25 mm	5.0 μm	white	smooth	non sterile	100 units
47 mm \varnothing	MPES010047N	Polietersulfona (PES)	47 mm	0.1 μm	white	smooth	non sterile	100 units
	MPES022047N	Polietersulfona (PES)	47 mm	0.22 μm	white	smooth	non sterile	100 units
	MPES010047N	Polietersulfona (PES)	47 mm	0.45 μm	white	smooth	non sterile	100 units

PTFE membrane filters

Filtration of aggressive solvents, phase separations, aerosols, and venting works

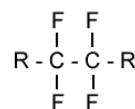

Description

The main features of polytetrafluoroethylene membranes (PTFE) are hydrophobic character and extraordinary chemical resistance to aggressive all solvents, acids, alkalis, except the phosphoric acid.

Recommended for use in the filtration of pure aggressive solvents, filtration of gases, aerosols, venting work, etc. In the filter if necessary aqueous samples, therefore it is necessary to moisten the membrane with an organic solvent such as ethanol or isopropanol.

Supplied in pores of 0.22, 0.45, 1.2 and 5.0 microns; in diameter and 13, 25, 47, 90, 142 and 293 mm in diameter.

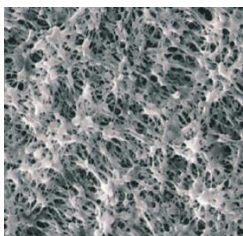

Advantages

- Hydrophobic nature
- Zero level of water extractables
- Special chemical compatibility
- High thermal resistance
- High flow with low pressure
- Autoclave at 134 ° C

Applications

- Filtration of samples of aggressive solvents and strong acids.
- Sterile venting applications in culture flasks, fermentation tanks and containers
- Pre-filtration air atmospheric control booths
- Phase separation
- Filtration of aerosols.

TECHNICAL SPECIFICATIONS

Bubble point with alcohol (minimum value)

0.22 μm	1.0 bar 100 Kpa
0.45 μm	0.5 bar 50 Kpa
1.2 μm	0.3 bar 30 Kpa
5.0 μm	- bar - Kpa

Flow rate with alcohol 25°C (Δp=0.7 bar) ml/min/cm²

0.22 μm	8
0.45 μm	12
1.2 μm	50
5.0 μm	250

Permeability to air (m³/m²/24 hours) Δp= 0.1 bar

0.22 μm	0.40
0.45 μm	0.61
1.2 μm	7.04
5.0 μm	8.54

Thickness: 0.190 – 0.250 mm

Membrane material
polytetrafluoroethylene (PTFE)

Diameters: 13, 25, 47, 90, 142 and 293 mm.

Pore sizes: 0.22, 0.45, 1.2 and 5.0 μm

Maximum temperature of use ≤ 130°C

Extractables with water: No

Sterilization: Using a γ radiation, ethylene oxide, autoclaving at 134°C

Chemical compatibility: 1– 14 pH

Reaction to water: hydrophobic

INFORMATION FOR ORDERS. PTFE membrane filters

	Code	Membrane material	Diameter	Pore size	Color	Surface	Format	Quantity
13 mm Ø	MPT022013N	PTFE	13 mm	0.22 µm	white	smooth	non sterile	100 units
	MPT045013N	PTFE	13 mm	0.45 µm	white	smooth	non sterile	100 units
	MPT120013N	PTFE	13 mm	1.2 µm	white	smooth	non sterile	100 units
	MPT500013N	PTFE	13 mm	5.0 µm	white	smooth	non sterile	100 units
25 mm Ø	MPT022025N	PTFE	25 mm	0.22 µm	white	smooth	non sterile	100 units
	MPT045025N	PTFE	25 mm	0.45 µm	white	smooth	non sterile	100 units
	MPT120025N	PTFE	25 mm	1.2 µm	white	smooth	non sterile	100 units
	MPT500025N	PTFE	25 mm	5.0 µm	white	smooth	non sterile	100 units
47 mm Ø	MPT022047N	PTFE	47 mm	0.22 µm	white	smooth	non sterile	100 units
	MPT045047N	PTFE	47 mm	0.45 µm	white	smooth	non sterile	100 units
	MPT120047N	PTFE	47 mm	1.2 µm	white	smooth	non sterile	100 units
	MPT500047N	PTFE	47 mm	5.0 µm	white	smooth	non sterile	100 units
90 mm	MPT022090G	PTFE	90 mm	0,22 µm	white	smooth	non sterile	25 units
	MPT045090G	PTFE	90 mm	0.45 µm	white	smooth	non sterile	25 units
142 mm Ø	MPT022142G	PTFE	142 mm	0.22 µm	white	smooth	non sterile	25 units
	MPT045142G	PTFE	142 mm	0.45 µm	white	smooth	non sterile	25 units
	MPT120142G	PTFE	142 mm	1.2 µm	white	smooth	non sterile	25 units
	MPT500142G	PTFE	142 mm	5.0 µm	white	smooth	non sterile	25 units
293 mm Ø	MPT022293G	PTFE	293 mm	0.22 µm	white	smooth	non sterile	25 units
	MPT045293G	PTFE	293 mm	0.45 µm	white	smooth	non sterile	25 units
	MPT120293G	PTFE	293 mm	1.2 µm	white	smooth	non sterile	25 units
	MPT500293G	PTFE	293 mm	5.0 µm	white	smooth	non sterile	25 units

Polypropylene membrane filters (PP)

Filtration of aqueous samples, aggressive solvents, ionic chromatography and gases

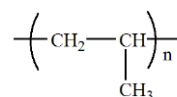

Description

These membranes are made from pure polypropylene, and therefore have excellent chemical compatibility against most of organic solvents.

Polypropylene is a material with an extremely low level of removals and is therefore recommended for filtration of samples in ion chromatography, to prolong the life of the column.

This is the preferred membrane filtration HPLC samples where the levels are below detection 230 nm.

Another important feature is its low nonspecific adsorption which is ideal for the filtration of critical samples with little presence of proteins.

Due to their hydrophobic nature, are used in industrial processes such as filtration of gases.

It is also interesting that a membrane to be a pure hydrocarbon, has no problem removing halogenated compounds as can happen with materials such as PTFE or PVDF.

Supplied in pores of 0.22 and 0.45 microns, and 25 in diameter and 47 mm in diameter.

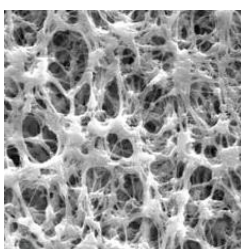

Advantages

- Hydrophobic nature
- Very low level of removals
- High chemical compatibility
- High flow with low pressure
- Low nonspecific adsorption of proteins
- Absence problems by elimination of halogenated compounds

Applications

- Filtration of aggressive solvents enough samples
- Filtration of gases in industrial processes
- Ion chromatography
- Sample filtration HPLC



TECHNICAL SPECIFICATIONS

Bubble point with alcohol (minimum value)

0.22 μm	0.8 bar 80 Kpa
0.45 μm	0.11 bar 11 Kpa

Flow rate with alcohol 25°C (Δp=0.7 bar) ml/min/cm²

0.22 μm	≤ 60
0.45 μm	≤ 140

Permeability to air (m3/m2/24 hours) Δp= 0.01 Mpa

0.22 μm	5.23
0.45 μm	6.83

Thickness: 0.170 – 0.200 mm

Membrane material

Polypropylene (PP)

Diameters: 25 and 47 mm.

Pores: 0.22 and 0.45 μm

Maximum temperature of use ≤ 50°C

Extractables with water: No

Chemical compatibility: 1 – 14 pH

Reaction to water: hydrophobic

INFORMATION FOR ORDERS. Polypropylene membrane filters (PP)

	Code	Membrane material	Diameter	Pore size	Color	Surface	Format	Quantity
25 mm	MPP022025N	Polypropilene (PP)	25 mm	0.22 µm	white	smooth	non sterile	100 units
	MPP022025N	Polypropilene (PP)	25 mm	0.45 µm	white	smooth	non sterile	100 units
47 mm	MPP022047N	Polypropilene (PP)	47 mm	0.22 µm	white	smooth	non sterile	100 units
	MPP010047N	Polypropilene (PP)	47 mm	0.45 µm	white	smooth	non sterile	100 units

PVDF Membrane filter

Filtration of aqueous samples, aggressive solvents and gases

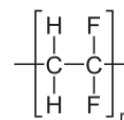

Description

Polyvinylidene fluoride (PVDF) is a material which demonstrates a high particle retention efficiency, excellent chemical compatibility, good mechanical strength, high thermal resistance and low nonspecific adsorption of proteins. Hydrophobic nature is only advisable for the filtration of aqueous samples if wetted with isopropanol or another alcohol. All these features make it very versatile and membrane used. Supplied in pores of 0.22 and 0.45 microns, and 25 in diameter and 47 mm in diameter.

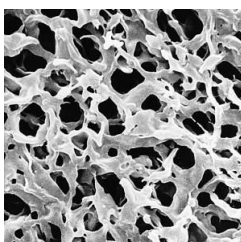

Advantages

- Hydrophobic nature
- Large chemical compatibility
- Excellent mechanical properties
- Good resistance to high temperatures
- Physiologically innocuous
- Low level extractables

Applications

- Different industrial products

TECHNICAL SPECIFICATIONS

Bubble point with alcohol (minimum value)

0.22 μm	1.0 bar 100 Kpa
0.45 μm	0.4 bar 40 Kpa

Flow rate with alcohol (s/100 ml H₂O/9.62 cm² to 24 inks Hg):

0.22 μm	≤ 10 - 15
0.45 μm	≤ 37 - 60

Permeability to air (m³/m²/24 hours) Δp= 0.01 Mpa

0.22 μm	2.06
0.45 μm	4.02

Thickness: 0.120 – 0.200 mm

Membrane material

Polyvinylidene fluoride (PVDF)

Diameter: 25 and 47 mm.

Pores: 0.22 and 0.45 μm

Maximum temperature of use ≤ 170°C

Maximum pressure: 8.7 psi

Extractables with water: Very low

Chemical compatibility: 1– 14 pH

Reaction to water: hydrophobic

Sterilizations: Autoclaving to 121°C, γ radiation

INFORMATION FOR ORDERS. PVDF membrane filters

	Code	Membrane material	Diameter	Pore size	Color	Surface	Format	Quantity
25 mm	MPV022025N	PVDF	25 mm	0.22 µm	white	smooth	non sterile	100 units
	MPV022025N	PVDF	25 mm	0.45 µm	white	smooth	non sterile	100 units
47 mm	MPV022047N	PVDF	47 mm	0.22 µm	white	smooth	non sterile	100 units
	MPV010047N	PVDF	47 mm	0.45 µm	white	smooth	non sterile	100 units

Polycarbonate membrane filters

Analyses of particles using a microscope, analyses of water and air. Made with *track etched* technology

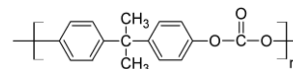

Description

Polycarbonate is a material with an almost perfect structure. The fabrication process is started with the production of polycarbonate film, next, the surface of the membrane is bombarded with electron beams, whereby the pores are exactly circular. Membrane is a hydrophilic nature and therefore it is advisable to use with aqueous and biological samples.

It comes in various pores between 0.1 microns and 20.0 microns, and at 13, 25 and 47 mm in diameter.

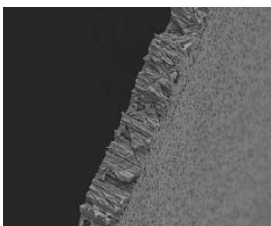
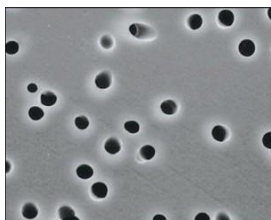

Advantages

- Hydrophilic nature
- Translucent to light through so it is recommended for analysis by microscope or binocular lens
- Almost perfect pore structure
- Low extractable
- Slightly hygroscopic
- Low metal content
- Excellent mechanical
- Autoclavable at 121 ° C

Applications

- Analyses of particles
- Environmental analyses
- Epifluorescence
- Biological culture
- Test of fuel
- Bio-assays
- Parasitological
- Analyses of air
- Analyses of water
- Analyses of legionella with a 0.4µm membrane in a sterile format according to ISO 11731 part I
- Determination of the presence of trichina in the tissue samples

TECHNICAL SPECIFICATIONS

Bubble point with water (minimum value)

0.1 µm	94 psi
0.22 µm	57 psi
0.4 µm	32 psi
0.8 µm	17 psi
2.0 µm	8 psi
3.0 µm	6 psi
5.0 µm	3.5 psi
8.0 µm	2.0 psi
12.0 µm	1.0 psi
14.0 µm	1.0 psi
20.0 µm	1.0 psi

Flow rate with water (ml/min/cm²) Δp= 10 psi

0.1 µm	2.5
0.22 µm	10
0.4 µm	33
0.8 µm	60
2.0 µm	300
3.0 µm	440
5.0 µm	700
8.0 µm	1000
12.0 µm	1250
14.0 µm	1400
20.0 µm	-

Flow rate with air (ml/min/cm²) Δp= 10 psi

0.1 µm	1.5
0.22 µm	3
0.4 µm	7.5
0.8 µm	18
2.0 µm	16.5
3.0 µm	75
5.0 µm	60
8.0 µm	60
12.0 µm	127
14.0 µm	127
20.0 µm	-

Thickness: 0.060 – 0.100 mm

Pore size: < 15%

Membrane material: Polycarbonate

Diameters: 13, 25 and 47 mm.

Maximum temperature in use ≤ 140°C

Extractables with water: very low

Chemical compatibility: 4– 8 pH

Reaction to water: hydrophilic

Sterilization: by autoclave at 121°C

INFORMATION FOR ORDERS. Polycarbonate membrane filters

	Code	Membrane material	Diameter	Pore size	Color	Surface	Format	Quantity
13 mm Ø	MPC0010013N	Polycarbonate	13 mm	0.1 µm	translucent	smooth	non sterile	100 units
	MPC0020013N	Polycarbonate	13 mm	0.2 µm	translucent	smooth	non sterile	100 units
	MPC0040013N	Polycarbonate	13 mm	0.4 µm	translucent	smooth	non sterile	100 units
	MPC0080013N	Polycarbonate	13 mm	0.8 µm	translucent	smooth	non sterile	100 units
	MPC0200013N	Polycarbonate	13 mm	2.0 µm	translucent	smooth	non sterile	100 units
	MPC0300013N	Polycarbonate	13 mm	3.0 µm	translucent	smooth	non sterile	100 units
	MPC0500013N	Polycarbonate	13 mm	5.0 µm	translucent	smooth	non sterile	100 units
	MPC0800013N	Polycarbonate	13 mm	8.0 µm	translucent	smooth	non sterile	100 units
	MPC1200013N	Polycarbonate	13 mm	12.0 µm	translucent	smooth	non sterile	100 units
	MPC1400013N	Polycarbonate	13 mm	14.00 µm	translucent	smooth	non sterile	100 units
	MPC2000013N	Polycarbonate	13 mm	20.0 µm	translucent	smooth	non sterile	100 units
25 mm Ø	MPC0010025N	Polycarbonate	25 mm	0.1 µm	translucent	smooth	non sterile	100 units
	MPC0020025N	Polycarbonate	25 mm	0.2 µm	translucent	smooth	non sterile	100 units
	MPC0040025N	Polycarbonate	25 mm	0.4 µm	translucent	smooth	non sterile	100 units
	MPC0080025N	Polycarbonate	25 mm	0.8 µm	translucent	smooth	non sterile	100 units
	MPC0200025N	Polycarbonate	25 mm	2.0 µm	translucent	smooth	non sterile	100 units
	MPC0300025N	Polycarbonate	25 mm	3.0 µm	translucent	smooth	non sterile	100 units
	MPC0500025N	Polycarbonate	25 mm	5.0 µm	translucent	smooth	non sterile	100 units
	MPC0800025N	Polycarbonate	25 mm	8.0 µm	translucent	smooth	non sterile	100 units
	MPC1200025N	Polycarbonate	25 mm	12.0 µm	translucent	smooth	non sterile	100 units
	MPC1400025N	Polycarbonate	25 mm	14.00 µm	translucent	smooth	non sterile	100 units
	MPC2000025N	Polycarbonate	25 mm	20.0 µm	translucent	smooth	non sterile	100 units
47 mm Ø	MPC0010047N	Polycarbonate	47 mm	0.1 µm	translucent	smooth	non sterile	100 units
	MPC0020047N	Polycarbonate	47 mm	0.2 µm	translucent	smooth	non sterile	100 units
	MPC0040047N	Polycarbonate	47 mm	0.4 µm	translucent	smooth	non sterile	100 units
	MPC0040047SN	Polycarbonate	47 mm	0.4 µm	translucent	smooth	sterile	200 units
	MPC0080047N	Polycarbonate	47 mm	0.8 µm	translucent	smooth	non sterile	100 units
	MPC0200047N	Polycarbonate	47 mm	2.0 µm	translucent	smooth	non sterile	100 units
	MPC0300047N	Polycarbonate	47 mm	3.0 µm	translucent	smooth	non sterile	100 units
	MPC0500047N	Polycarbonate	47 mm	5.0 µm	translucent	smooth	non sterile	100 units
	MPC0800047N	Polycarbonate	47 mm	8.0 µm	translucent	smooth	non sterile	100 units
	MPC1200047N	Polycarbonate	47 mm	12.0 µm	translucent	smooth	non sterile	100 units
	MPC1400047N	Polycarbonate	47 mm	14.00 µm	translucent	smooth	non sterile	100 units
	MPC2000047N	Polycarbonate	47 mm	20.0 µm	translucent	smooth	non sterile	100 units

Regenerated cellulose membrane filters

Hydrophilic membrane compatible with various solvents including acetonitrile

Description

The regenerated cellulose is a membrane with excellent resistance to temperature (up to 180 ° C) and outstanding mechanical strength. Its chemical resistance is high (pH 3-12) and in the case of biological sample filtration it is characterized by a very low non-specific adsorption of proteins (<10 µg / cm² of bovine serum albumin)
It is supplied in various pores of 0.22 µm and 0.45 µm; 25 and 47 mm in diameter.

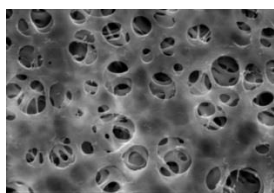

Advantages

- Hydrophilic nature.
- Low non-specific protein adsorption
- Excellent mechanical resistance.
- Autoclavable at 121°C.
- Resistant to high temperatures
- Good chemical compatibility with some solvents and acetonitrile

Applications

- Mobile Phases in HPLC
- Filtration of aqueous samples
- Analytical preparation of samples
- Chromatography
- Clarification of samples
- Analysis with protein chemistry
- Filtration of organic samples

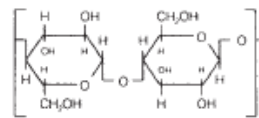

TECHNICAL SPECIFICATIONS

Bubble point with water (minimum value)

0.2 µm	63.8 psi
0.45 µm	40.6 psi

Flow rate with water (ml/min/cm²) Δp= 14.5 psi

0.2 µm	16
0.45 µm	28

Thickness: 0.160 – 0.200 mm

Membrane material: Regenerated cellulose reinforced with nonwoven.

Diameters: 25 y 47 mm.

Maximum temperature in use ≤ 180°C

Maximum work pressure: 8.7 psi

Extractables with water: < 1%

Chemical compatibility: 3– 12 pH

Reaction to water: hydrophilic

Sterilization: By autoclaving at 121 ° C or 134 ° C, dry heat at 180 ° C, γ-radiation, ethylene oxide

INFORMATION FOR ORDERS. Regenerated cellulose membrane filters

	Code	Membrane material	Diameter	Pore size	Color	Surface	Format	Quantity
25 mm	MRC022025N	Regenerated cel.	25 mm	0.22 µm	white	smooth	non sterile	100 units
	MRC022025N	Regenerated cel.	25 mm	0.45 µm	white	smooth	non sterile	100 units
47 mm	MRC022047N	Regenerated cel.	47 mm	0.22 µm	white	smooth	non sterile	100 units
	MRC010047N	Regenerated cel.	47 mm	0.45 µm	white	smooth	non sterile	100 units

Polyester membrane filters

Manufactured with *track etched* technology to ensure absolute pore size

Description

Polyester (PET) is a hydrophilic membrane with good temperature resistance (up to 140 °C) and a semi-translucent color.

Its chemical resistance is very high and in the case of biological sample filtration it is characterized by very low non-specific adsorption of proteins (<5 µg / cm² of bovine serum albumin).

It is supplied in various pores of 0.22 µm and 0.45 µm; And in 25 and 47 mm in diameter.



Advantage

- Hydrophilic nature.
- Low non-specific protein adsorption
- Sterilization by radiation or ethylene oxide
- Resistant to high temperatures (140°C)
- Good chemical compatibility with most solvents.
- Its surface captures 100% of particles larger than their pore size.
- Structure similar to polycarbonate but with higher chemical resistance

Applications

- Mobile Phases in HPLC
- Filtration of aqueous samples
- Analysis with protein chemistry
- Filtration of organic samples
- Retention of some bacteria and microorganisms
- Elimination of red blood cells from plasma
- Flow control of the reagents by means of tests

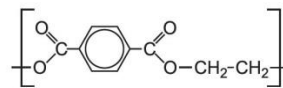
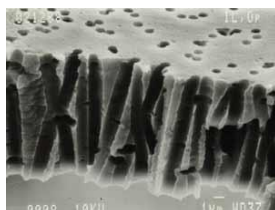

TECHNICAL SPECIFICATIONS

Bubble point with water (minimum value)

0.2 µm	20.0 psi
0.45 µm	12.0 psi

Flow rate with water (ml/min/cm²) Δp= 14.5 psi

0.2 µm	10
0.45 µm	33

Flow rate with air (L/min/cm²) Δp= 10 psi

0.2 µm	3
0.45 µm	7.5

Thickness: 0.100 – 0.200 mm

Pore density:

0.2 µm	3 x 10 ⁸
0.45 µm	1 x 10 ⁸

Membrane material: Polyester

Diameter: 25 y 47 mm.

Maximum temperature in use ≤ 140°C

Maximum work pressure: 8.7 psi

Extractables with water: < 1%

Protein absorption: 5 µg/cm²

Chemical compatibility: 4 – 8 pH

Reaction to water: hydrophilic

Sterilization: By autoclaving at 121 °C or 134 °C, dry heat at 180 °C, γ-radiation, ethylene oxide

INFORMATION FOR ORDERS. Polyester membrane filters

	Code	Membrane material	Diameter	Pore size	Color	Surface	Format	Quantity
25 mm	MPS022025N	Polyester	25 mm	0.22 µm	white	smooth	non sterile	100 units
	MPS022025N	Polyester	25 mm	0.45 µm	blanco	smooth	non sterile	100 units
47 mm	MPS022047N	Polyester	47 mm	0.22 µm	blanco	smooth	non sterile	100 units
	MPS010047N	Polyester	47 mm	0.45 µm	blanco	smooth	non sterile	100 units

SYRINGE FILTER GUIDE FILTER-LAB®

MEMBRANE MATERIAL	PORE SIZE (µm)	DIAMETER	FORMAT	CONNECTORS	MAX. TEMPERATURE
Cellulose acetate	0.22	13	sterile	Inlet: Female luer lock	≤ 50° C
	0.45	25	non sterile	Outlet: Male luer slip	
	0.8	30			
	1.2				
	5.0				
Glass fiber + Cel. Acetate	Prefilter + 0.22 µm	25	non sterile	Inlet: Female luer lock Outlet: Male luer slip	≤ 50° C
	Prefilter + 0.45 µm				
Fibra de vidrio + Nylon	Prefilter + 0.22 µm	25	non sterile	Inlet: Female luer lock Outlet: Male luer slip	≤ 50° C
	Prefilter + 0.45 µm				
Glass microfiber	Retention 0.7 µm (Filtración de profundidad)	25	non sterile	Inlet: Female luer lock Outlet: Male luer slip	≤ 180° C
Poliethersulphone (PES)	0.1	13	sterile	Inlet: Female luer lock Outlet: Male luer slip	≤ 90° C
	0.22	25	non sterile		
	0.45				
Poliamide (nylon)	0.22	13	non sterile	Inlet: Female luer lock Outlet: Male luer slip	≤ 100° C
	0.45	25			
		30			
Polytetrafluore ethylene (PTFE) Hydrophobic	0.22	4	non sterile	Inlet: Female luer lock Outlet: Male luer slip	≤ 130° C
	0.45	13			
		25			
		30			
Polytetrafluore ethylene (PTFE) Hydrophilic	0.22	4	non sterile	Inlet: Female luer lock Outlet: Male luer slip	≤ 130° C
	0.45	13			
		25			
		30			
Polifluoruro de polivinilideno (PVDF) Hidrofilico	0.22	13	non sterile	Inlet: Female luer lock Outlet: Male luer slip	≤ 100° C
	0.45	25	sterile		
		30			
Polyvinilidene fluoryde (PVDF) Hydrophobic	0.22	13	non sterile	Inlet: Female luer lock Outlet: Male luer slip	≤ 100° C
	0.45	25			
		30			
Polypropilene (PP)	0.22	13	non sterile	Inlet: Female luer lock Outlet: Male luer slip	≤ 50° C
	0.45	25			
Regenerated cellulose (RC)	0.22	13	non sterile	Inlet: Female luer lock Outlet: Male luer slip	≤ 50° C
	0.45	25			



CHEMICAL COMPATIBILITY (pH)	PROTEIN ABSORPTION	EXTRACTABLES w WATER	WETTABILITY	PAGE
4-8	Very low	< 0.2%	Hydrophilic	112
4-8	Very low	< 0.2%	Hydrophilic	114
3-11	High	< 0.2%	Hydrophilic	114
3-11	Low	< 0.2%	Hydrophilic	116
1-14	Very low	< 0.2%	Hydrophilic	118
3-12	Very high	< 0.2%	Hydrophilic	120
1-14	No	< 0.2%	Hydrophobic	122
1-14	No	< 0.2%	Hydrophobic	124
1-14	Very low 0.45	< 0.2%	Hydrophilic	124
1-14	Very low	< 0.2%	Hydrophobic	126
1-14	Low	< 0.2%	Hydrophilic	128
3-12	Low	< 0.2%	Hydrophilic	130

Cellulose acetate syringe filters

Clarification, purification and sterilization of aqueous samples and biological samples

Description

These filters with cellulose acetate membrane whose main properties are: low absorption and non specific adsorption of proteins, and their high flow rate. All these properties make them very valid for the filtration of aqueous samples and biological samples. These syringe filters are available in a sterile format (individual blister) and non sterile, in pores of 0.22 and 5.0 µm and in dimensions of 13, 25 and 30 mm of diameter.



Advantages

- Hydrophilic nature
- Low absorption non-specifically in proteins
- High run flow
- Very regular pore's structure
- Large range of pore
- Free of nitrates
- Sterile and non sterile format

Applications

- Sterilization of aqueous samples (0.22 µm)
- Filtration of serum samples (0.22 µm)
- Preparation of biological samples (0.45 µm)
- Preparation of protein samples
- Determination of silting index with samples of wine (5.0, 1.2 µm)
- Filtration of food samples (1.2 y 0.8 µm)
- Pre filtration of aqueous samples (5.0 y 1.2 µm)
- Filtration of medicines (0.45 y 0.22 µm)
- Preparation of aqueous samples for HPLC.
- Filtration of cultivate media
- Filtration of subway water

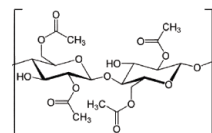

TECHNICAL SPECIFICATIONS

Bubble point with water (minimum value)

0.2 µm	2.8 bar 280 Kpa
0.45 µm	1.6 bar 160 Kpa
0.8 µm	0.8 bar 80 Kpa
1.2 µm	0.6 bar 60 Kpa
5.0 µm	0.4 bar 40 Kpa

Flow rate with water (ml/min /cm²) Δp=0.7 bar | 70 Kpa aprox.:

0.2 µm	10 ml/min/cm²
0.45 µm	30 ml/min/cm²
0.8 µm	45 ml/min/cm²
1.2 µm	100 ml/min/cm²
5.0 µm	200 ml/min/cm²

Thickness: 0.100 – 0.150 mm

Materials

Membrane: Cellulose acetate
Housing: Polypropylene (PP)

Diameters: 13, 25, 30 mm.

Filtration area

13 mm diameter:	0.92 cm²
25 mm diameter:	2.98 cm²
30 mm diameter:	4.90 cm²

Maximum temperature of use ≤ 50°C

Maximum pressure of work: 8.7 psi

Connectors

Input: Female luer lock
Output: Male luer slip

Hold-up volume

13 mm diameter:	< 10 µl
25 mm diameter:	< 30 µl
30 mm diameter:	< 55 µl

Extractables with water < 0.2%

Chemical compatibility: 4 – 8 pH

Reaction to water: hydrophilic

Absorption: low absorption non-specific in proteins.

INFORMATION FOR ORDERS. Cellulose acetate syringe filters

	Code	Membrane	Housing	Diameter	Pore	Inlet/Outlet	Format	Quantity
0.22 μ m	JCA022013N	Cellulose acetate	Polypropylene	13 mm.	0.22 μ m	luer lock/luer slip	non sterile	100 units
	JCA022013R	Cellulose acetate	Polypropylene	13 mm.	0.22 μ m	luer lock/luer slip	non sterile	1.000 units
	JCA022013K	Cellulose acetate	Polypropylene	13 mm.	0.22 μ m	luer lock/luer slip	sterile, ind.	50 units
	JCA022025N	Cellulose acetate	Polypropylene	25 mm.	0.22 μ m	luer lock/luer slip	non sterile	100 units
	JCA022025R	Cellulose acetate	Polypropylene	25 mm.	0.22 μ m	luer lock/luer slip	non sterile	1.000 units
	JCA022025K	Cellulose acetate	Polypropylene	25 mm.	0.22 μ m	luer lock/luer slip	sterile, ind.	50 units
	JCA022030N	Cellulose acetate	Polypropylene	30 mm.	0.22 μ m	luer lock/luer slip	non sterile	100 units
	JCA022030R	Cellulose acetate	Polypropylene	30 mm.	0.22 μ m	luer lock/luer slip	non sterile	1.000 units
JCA022030K	Cellulose acetate	Polypropylene	30 mm.	0.22 μ m	luer lock/luer slip	sterile, ind.	50 units	
0.45 μ m	JCA045013N	Cellulose acetate	Polypropylene	13 mm.	0.45 μ m	luer lock/luer slip	non sterile	100 units
	JCA045013R	Cellulose acetate	Polypropylene	13 mm.	0.45 μ m	luer lock/luer slip	non sterile	1.000 units
	JCA045013K	Cellulose acetate	Polypropylene	13 mm.	0.45 μ m	luer lock/luer slip	sterile, ind.	50 units
	JCA045025N	Cellulose acetate	Polypropylene	25 mm.	0.45 μ m	luer lock/luer slip	non sterile	100 units
	JCA045025R	Cellulose acetate	Polypropylene	25 mm.	0.45 μ m	luer lock/luer slip	non sterile	1.000 units
	JCA045025K	Cellulose acetate	Polypropylene	25 mm.	0.45 μ m	luer lock/luer slip	sterile, ind.	50 units
	JCA045030N	Cellulose acetate	Polypropylene	30 mm.	0.45 μ m	luer lock/luer slip	non sterile	100 units
	JCA045030R	Cellulose acetate	Polypropylene	30 mm.	0.45 μ m	luer lock/luer slip	non sterile	1.000 units
JCA045030K	Cellulose acetate	Polypropylene	30 mm.	0.45 μ m	luer lock/luer slip	sterile, ind.	50 units	
0.8 μ m	JCA080025N	Cellulose acetate	Polypropylene	25 mm.	0.8 μ m	luer lock/luer slip	non sterile	100 units
	JCA080025R	Cellulose acetate	Polypropylene	25 mm.	0.8 μ m	luer lock/luer slip	non sterile	1.000 units
	JCA080025K	Cellulose acetate	Polypropylene	25 mm.	0.8 μ m	luer lock/luer slip	sterile, ind.	50 units
5.0 μ m	JCA500025N	Cellulose acetate	Polypropylene	25 mm.	5.0 μ m	luer lock/luer slip	non sterile	100 units
	JCA500025R	Cellulose acetate	Polypropylene	25 mm.	5.0 μ m	luer lock/luer slip	non sterile	1.000 units
	JCA500025K	Cellulose acetate	Polypropylene	25 mm.	5.0 μ m	luer lock/luer slip	sterile, ind.	50 units

Syringe filters with glass microfiber prefilter

Clarification and sterilization of samples with high particle charge

Description

These filters syringe filter containing a cellulose acetate or polyamide (nylon) membrane of 0.22 microns or 0.45 microns, along with a glass microfiber pre-filter with retention of 0.7 microns particles. This depth pre-filter prevents premature clogging of the final membrane. They are particularly suitable for filtration and sterilization especially difficult samples with high solids loading, or high power silting deformable.

Supplied in diameter 25 mm in non-sterile format.

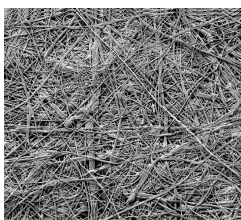

Advantatges

- Compatibility with water: hydrophilic
- These filters avoid the premature silting of the final membrane

Applications

- Sterilization of aqueous samples with colloidal samples (0.22 µm)
- Clarification of dirty aqueous samples (0.45 µm)
- Filtration of difficult samples in HPLC.



TECHNICAL SPECIFICATIONS

Bubble point with water (minimum value)

Cellulose acetate

Pre filter + 0.22 µm 3.5 bar | 350 Kpa
Pre filter + 0.45 µm 1.6 bar | 160 Kpa

Polyamide (nylon)

Pre filter + 0.22 µm 2.8 bar | 280 Kpa
Pre filter + 0.45 µm 1.8 bar | 180 Kpa

Flow rate with water (ml/min /cm²) Δp=0.7 bar | 70 Kpa aprox.:

Cellulose acetate

Pre filter + 0.22 µm 10 ml/min/cm²
Pre filter + 0.45 µm 20 ml/min/cm²

Polyamide (nylon)

Pre filter + 0.22 µm 2.5 ml/min/cm²
Pre filter + 0.45 µm 8.0 ml/min/cm²

Materials

Pre filter: Glass microfiber filters with binders
Membrane: Cellulose acetate or polyamide (nylon)
Housing: Polypropylene (PP)

Diameter: 25 mm.

Filtration area

2,98 cm²

Maximum temperature of use

Cellulose acetat e≤ 50°C
Polyamide (nylon) ≤ 100°C

Maximum pressure of work: 8.7 psi

Connectors

Input: Female luer lock
Output: Male luer slip

Hold-up volume

25 mm diameter: < 30 µl

Extractables with water < 0.2%

Chemical compatibility:

Cellulose acetate: 4 – 8 pH
Polyamide (nylon): 3- 12 pH

Reaction to water: hydrophilic

INFORMATION FOR ORDERS. Syringe filters with cellulose acetate or nylon + glass microfiber

Code	Membrane	Housing	Diameter	Pore	Inlet/Outlet	Format	Quantity
JGFC A022025N	Glass fiber + Cel. Acetate	Polypropylene	25 mm.	0.22 µm	luer lock/luer slip	non sterile	100 units
JGFC A022025R	Glass fiber + Cel. Acetate	Polypropylene	25 mm.	0.22 µm	luer lock/luer slip	non sterile	1000 units
JGFNY022025N	Fibra vidrio + nylon	Polipropileno	25 mm.	0.22 µm	luer lock/luer slip	non sterile	100 units
JGFNY022025R	Fibra vidrio + nylon	Polipropileno	25 mm.	0.22 µm	luer lock/luer slip	non sterile	1000 units
JGFC A045025N	Glass fiber + Cel. Acetate	Polypropylene	25 mm.	0.45 µm	luer lock/luer slip	non sterile	100 units
JGFC A045025R	Glass fiber + Cel. Acetate	Polypropylene	25 mm.	0.45 µm	luer lock/luer slip	non sterile	1000 units
JGFNY045025N	Fibra vidrio + nylon	Polipropileno	25 mm.	0.45 µm	luer lock/luer slip	non sterile	100 units
JGFNY045025R	Fibra vidrio + nylon	Polipropileno	25 mm.	0.45 µm	luer lock/luer slip	non sterile	1000 units

Glass microfiber syringe filters

Quick pre-filtration of samples with high particle charge

Description

The housing incorporates a glass microfiber filter with binders. These filters are useful in the pre-filtration of turbid samples with high loads which can cause premature clogging of the membrane. Can also be used as a pre-filter in combination with each connecting syringe filters. They are supplied in 25 mm format and non sterile.

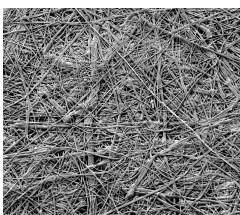

Advantages

- Hydrophilic reaction to water
- Excellent compatibility with organic solvents and hard acids (but hydrofluoric acid) and bases.
- High charge capacity

Applications

- Pre-filtration of difficult samples before the filtration with syringe filters with membrane of 0.2 or 0.45 μm .
- Pre-filtration of turbid samples with high particle charge.
- In venting tasks in machines for the determination for the content in nicotine of tobacco
- Filtration of culture media before being sterilized
- Pre-filtration of serum samples and cellular culture before their analyses



TECHNICAL SPECIFICATIONS

Flow rate with water (ml/min /cm²) $\Delta p=0.7$ bar | 70 Kpa aprox.:

Retention 0.7 μm ≤ 100 ml/min/cm²
 Retention 1.0 μm ≤ 183 ml/min/cm²

Materials

Membrane: Glass microfiber with binders
 Housing: Polypropylene (PP)

Retention

0.7 μm
 1.0 μm

Diameter: 25 mm.

Filtration area

2,98 cm²

Maximum temperature of use $\leq 180^\circ\text{C}$

Maximum pressure of work: 8.7 psi

Connectors

Inlet: Female luer lock
 Outlet: Male luer slip

Hold-up volume

25 mm diameter: < 30 μl

Extractables with water < 0.2%

Chemical compatibility: 3 – 11 pH

Reaction to water: hydrophilic

INFORMATION FOR ORDERS. Glass microfiber syringe filters

	Code	Membrane	Housing	Diameter	Inlet/Outlet	Format	Quantity
0.7 μm	JGF070025N	Glass fiber	Polypropylene	25 mm.	luer lock/luer slip	non sterile	100 units
	JGF070025R	Glass fiber	Polypropylene	25 mm.	luer lock/luer slip	non sterile	1000 units
1.0 μm	JGF100025N	Glass fiber	Polypropylene	25 mm.	luer lock/luer slip	non sterile	100 units
	JGF100025R	Glass fiber	Polypropylene	25 mm.	luer lock/luer slip	non sterile	1000 units

Polyethersulphone syringe filters (PES)

Purification, sterilization and ultra-filtration of biological and aqueous samples

Description

The polyethersulphone (PES) is a very interesting material at the ultra cleaning and sterilization of aqueous and biological samples, because of its high flow rate with low pressure. Also, its chemical compatibility is very good. They are available in a sterile format and non sterile format and in 13 and 25 mm of diameter. Membranes of 0.1, 0.22 and 0.45 μm .

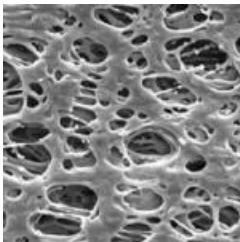

Advantages

- High velocity of filtration
- Low level of extractable
- Non specifically low absorption of proteins
- Rnase-free, Dnase-free, DNA-free certifications and free of pyrogenic

Applications

- Ultra filtration of aqueous samples (0.1 μm)
- Sterilization of aqueous samples, biological samples and pharmaceutical solutions (0.2 μm)
- Environmental analysis (0.45 μm)
- Sterile filtration of culture media and additives for culture media



TECHNICAL SPECIFICATIONS

Bubble point with water (minimum value)

0.1 μm	2.0 bar 200 Kpa (alcohol)
0.22 μm	3.5 bar 350 Kpa
0.45 μm	2.2 bar 220 Kpa

Flow rate with water (ml/min /cm² $\Delta p=0.7$ bar | 70 Kpa aprox.:

0.1 μm	5 ml/min/cm ²
0.22 μm	10 ml/min/cm ²
0.45 μm	25 ml/min/cm ²

Thickness: 0.110 – 0.130 mm

Materials

Membrane: Polyethersulphone (PES)
Housing: Polypropylene (PP)

Diameters: 13, 25 mm.

Filtration area

13 mm diameter: 0.92 cm²
25 mm diameter: 2.98 cm²

Maximum temperature of use $\leq 90^\circ\text{C}$

Maximum pressure of work: 8.7 psi

Connectors

Inlet: Female luer lock
Outlet: Male luer slip

Hold-up volume

13 mm diameter: < 20 μl
25 mm diameter: < 100 μl

Extractables with water < 0.2%

Chemical compatibility: 1 – 14 pH

Reaction to water: hydrophilic

Absorption: non specifically low absorption in proteins

INFORMATION FOR ORDERS. Polyethersulfone (PES) syringe filters

	Code	Membrane	Carcasa	Diameter	Pore	Inlet/Outlet	Format	Quantity
0.1	JPESS010025K	Polyethersulphone	Polypropylene	25 mm.	0.1 μm	luer lock/luer slip	sterile, ind.	50 units
0.22 μm	JPES022013N	Polyethersulphone	Polipropileno	13 mm.	0.22 μm	luer lock/luer slip	non sterile	100 units
	JPES022013R	Polyethersulphone	Polipropileno	13 mm.	0.22 μm	luer lock/luer slip	non sterile	1000 units
	JPESS022025K	Polyethersulphone	Polipropileno	25 mm.	0.22 μm	luer lock/luer slip	sterile, ind.	50 units
	JPES022025N	Polyethersulphone	Polipropileno	25 mm.	0.22 μm	luer lock/luer slip	non sterile	100 units
	JPES022025R	Polyethersulphone	Polipropileno	25 mm.	0.22 μm	luer lock/luer slip	non sterile	1000 units
	0.45 μm	JPES045013N	Polyethersulphone	Polipropileno	13 mm.	0.45 μm	luer lock/luer slip	non sterile
JPES045013R		Polyethersulphone	Polipropileno	13 mm.	0.45 μm	luer lock/luer slip	non sterile	1000 units
JPESS045025K		Polyethersulphone	Polipropileno	25 mm.	0.45 μm	luer lock/luer slip	sterile, ind.	50 units
JPES045025N		Polyethersulphone	Polipropileno	25 mm.	0.45 μm	luer lock/luer slip	non sterile	100 units
JPES045025R		Polyethersulphone	Polipropileno	25 mm.	0.45 μm	luer lock/luer slip	non sterile	1000 units

Polyamide syringe filters (Nylon)

Very used in filtration of samples for HPLC and in diverse analytical applications

Description

Syringe filters of hydrophilic nature. They have become in a global standard for the filtration of HPLC samples. They are also used in analytical applications and in the filtration of all types of samples, except aggressive solvents. All of that thanks to its porous structure and its good chemical stability.

They are available in a non sterile format and diameters 13, 25 and 30 mm

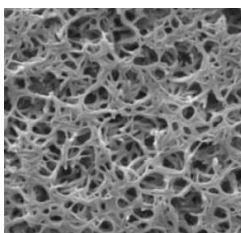

Advantages

- Hydrophilic reaction to water
- High non specifically absorption of proteins
- Good range of chemical compatibilities
- Low level of extractables
- Excellent physical resistance
- Good charging capacity

Applications

- Preparation of aqueous and organically samples in HPLC.
- Filtration of aqueous samples (non acids), diluted organic solvents, etc.
- Sterilization and clarification of biological liquids.
- Filtration of industrial water in the production of electric semiconductors.

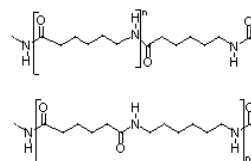

TECHNICAL SPECIFICATIONS

Bubble point with water (minimum value)

0.22 µm	2.8 bar 280 Kpa
0.45 µm	1.8 bar 180 Kpa

Flow rate with water (ml/min /cm²) Δp=0.7 bar | 70 Kpa aprox.:

0.22 µm	2.5 ml/min/cm ²
0.45 µm	8.0 ml/min/cm ²

Thickness: 0.100 – 0.120 mm

Materials

Membrane: Polyamide 66 (Nylon)
Housing: Polypropylene (PP)

Diameters: 13, 25, 30 mm.

Filtration area

13 mm diameter:	0.92 cm ²
25 mm diameter:	2.98 cm ²
30 mm diameter:	4.90 cm ²

Maximum temperature of use ≤ 100°C

Maximum pressure of work: 8.7 psi

Connectors

Inlet: Female luer lock
Outlet: Mal luer slip

Hold-up volume

13 mm diameter:	< 20 µl
25 mm diameter:	< 100 µl
30 mm diameter:	< 100 µl

Extractables with water < 0.2%

Chemical compatibility: 3 – 12 pH

Reaction to water: hydrophilic

Absorption: Non specific high adsorption of proteins

INFORMATION FOR ORDERS. Polyamide syringe filters (Nylon)

	Code	Membrane	Housing	Diameter	Pore	Inlet/Outlet	Format	Quantity
0.22 μm	JNY022013N	Nylon	Polypropylene	13 mm.	0.22 μm	luer lock/luer slip	non sterile	100 units
	JNY022013R	Nylon	Polypropylene	13 mm.	0.22 μm	luer lock/luer slip	non sterile	1000 units
	JNY022025N	Nylon	Polypropylene	25 mm.	0.22 μm	luer lock/luer slip	non sterile	100 units
	JNY022025R	Nylon	Polypropylene	25 mm.	0.22 μm	luer lock/luer slip	non sterile	1000 units
	JNY022030N	Nylon	Polypropylene	30 mm.	0.22 μm	luer lock/luer slip	non sterile	100 units
	JNY022030R	Nylon	Polypropylene	30 mm.	0.22 μm	luer lock/luer slip	non sterile	1000 units
0.45 μm	JNY045013N	Nylon	Polypropylene	13 mm.	0.45 μm	luer lock/luer slip	non sterile	100 units
	JNY045013R	Nylon	Polypropylene	13 mm.	0.45 μm	luer lock/luer slip	non sterile	1000 units
	JNY045025N	Nylon	Polypropylene	25 mm.	0.45 μm	luer lock/luer slip	non sterile	100 units
	JNY045025R	Nylon	Polypropylene	25 mm.	0.45 μm	luer lock/luer slip	non sterile	1000 units
	JNY045030N	Nylon	Polypropylene	30 mm.	0.45 μm	luer lock/luer slip	non sterile	100 units
	JNY045030R	Nylon	Polypropylene	30 mm.	0.45 μm	luer lock/luer slip	non sterile	1000 units
5.0 μm	JNY500025N	Nylon	Polypropylene	25 mm.	5.0 μm	luer lock/luer slip	non sterile	100 units
	JNY500025R	Nylon	Polypropylene	25 mm.	5.0 μm	luer lock/luer slip	non sterile	1000 units

Hydrophobic PTFE syringe filters

Recommended on the fabrication of aggressive solvents samples, acids and bases, filtration of gases and aerosols.

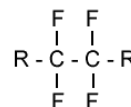

Description

The main property of these filters is their hydrophobic nature, this nature does not permit the filtration of aqueous samples, nevertheless this is ideal in the filtration of gases and venting works. Likewise, the polytetrafluoroethylene (PTFE) is an extraordinary resistant material against all the solvents and existent acids except the phosphoric acid. They are available in a non-sterile format and in 4, 13, 25 and 30mm of diameter.

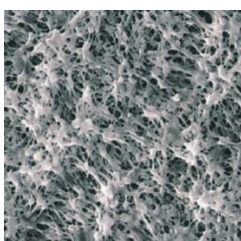

Advantages

- Hydrophobic nature but we can filter aqueous samples if the membrane is moisture with ethanol or isopropanol.
- Is compatible with the majority of pure solvents and acids, but the phosphoric acid.
- High run flow.
- Excellent physical resistance.
- Large range of diameters.

Applications

- Filtration of samples of aggressive samples, acids and bases.
- Filtration of samples in HPLC.
- Degasification of solvents.
- Sterilization of air by venting.
- Protection of vacuum pump in filtration equipments of laboratory.
- Sampling of aerosols.
- Filtration of gases.
- Venting of semi-automatic pipettes

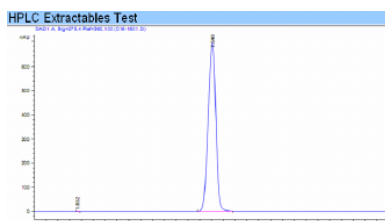

TECHNICAL SPECIFICATIONS

Bubble point with alcohol (minimum value)

0.22 µm	1.0 bar 100 Kpa
0.45 µm	0.5 bar 50 Kpa
5.0 µm	- bar Kpa

Flow rate with alcohol (ml/min /cm²) Δp=0.7 bar | 70 Kpa aprox.:

0.22 µm	8 ml/min/cm ²
0.45 µm	12 ml/min/cm ²
5.0 µm	195 ml/min/cm ²

Thickness: 0.190 – 0.250 mm

Materials

Membrane: Polytetrafluoroethylene (PTFE)
Housing: Polypropylene (PP)

Diameters: 4, 13, 25, 30 mm.

Filtration area

4 mm diámetro:	0.125 cm ²
13 mm diámetro:	0.92 cm ²
25 mm diámetro:	2.98 cm ²
30 mm diámetro:	4.90 cm ²

Maximum temperature of use ≤ 130°C

Maximum pressure of work: 8.7 psi

Connectors

Inlet: Female luer lock
Outlet: Male luer slip

Hold-up volume

4 mm diámetro:	< 5 µl
13 mm diámetro:	< 10 µl
25 mm diámetro:	< 30 µl
30 mm diámetro:	< 55 µl

Extractables with water < 0.2%

Chemical compatibility: 1 – 14 pH

Reaction to water: hydrophobic

Sterilization: By γ radiation, ethylene oxide or autoclaving at 121°C.

INFORMATION FOR ORDERS. Hydrophobic PTFE syringe filters

	Code	Membrane	Housing	Diameter	Pore	Inlet/Outlet	Format	Quantity
0.22 μm	JPT022004K	hydrophobic PTFE	Polypropylene	4 mm.	0.22 μm	luer lock/luer slip	non sterile	50 units
	JPT022013N	hydrophobic PTFE	Polypropylene	13 mm.	0.22 μm	luer lock/luer slip	non sterile	100 units
	JPT022013R	hydrophobic PTFE	Polypropylene	13 mm.	0.22 μm	luer lock/luer slip	non sterile	1000 units
	JPT022025N	hydrophobic PTFE	Polypropylene	25 mm.	0.22 μm	luer lock/luer slip	non sterile	100 units
	JPT022025R	hydrophobic PTFE	Polypropylene	25 mm.	0.22 μm	luer lock/luer slip	non sterile	1000 units
	JPT022030N	hydrophobic PTFE	Polypropylene	30 mm.	0.22 μm	luer lock/luer slip	non sterile	100 units
	JPT022030R	hydrophobic PTFE	Polypropylene	30 mm.	0.22 μm	luer lock/luer slip	non sterile	1000 units
0.45 μm	JPT045004K	hydrophobic PTFE	Polypropylene	4 mm.	0.45 μm	luer lock/luer slip	non sterile	50 units
	JPT045013N	hydrophobic PTFE	Polypropylene	13 mm.	0.45 μm	luer lock/luer slip	non sterile	100 units
	JPT045013R	hydrophobic PTFE	Polypropylene	13 mm.	0.45 μm	luer lock/luer slip	non sterile	1000 units
	JPT045025N	hydrophobic PTFE	Polypropylene	25 mm.	0.45 μm	luer lock/luer slip	non sterile	100 units
	JPT045025R	hydrophobic PTFE	Polypropylene	25 mm.	0.45 μm	luer lock/luer slip	non sterile	1000 units
	JPT045030N	hydrophobic PTFE	Polypropylene	30 mm.	0.45 μm	luer lock/luer slip	non sterile	100 units
	JPT045030R	hydrophobic PTFE	Polypropylene	30 mm.	0.45 μm	luer lock/luer slip	non sterile	1000 units
5.0 μm	JPT500025N	hydrophobic PTFE	Polypropylene	25 mm.	5.0 μm	luer lock/luer slip	non sterile	100 units
	JPT500025R	hydrophobic PTFE	Polypropylene	25 mm.	5.0 μm	luer lock/luer slip	non sterile	1000 units

Hydrophilic PTFE syringe filters

Recommended in the filtration of aqueous, biological samples and samples with aqueous / organic mixture

Description

These syringe filters have a special hydrophilic PTFE membrane that makes it a versatile filter for aqueous samples as well as for aggressive solvents. Low level of extractables, high flow rate and total versatility make it the most suitable filter in laboratories with filtration of both aqueous and solvent samples. They are available in non-sterile format and in 13, 25 and 30 mm diameter.

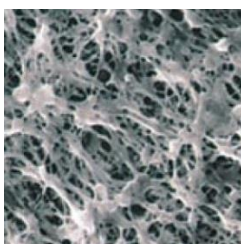

Advantages

- Hydrophilic nature.
- It is compatible with aqueous samples and also with aggressive solvents
- It has high flow rates.
- Low coefficient of friction of the surface of the membrane.
- Excellent physical resistance.
- Very low level of extractables.

Applications

- Filtration of HPLC and other samples with a mixture of aqueous and organic solvents
- Filtration of mobile phases
- Filtration of aqueous samples

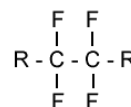

TECHNICAL SPECIFICATIONS

Bubble point with alcohol (minimum value)

0.22 µm	1.6 bar 160 Kpa
0.45 µm	0.7 bar 70 Kpa

Flow rate with alcohol (ml/min /cm²) Δp=0.7 bar | 70 Kpa aprox.:

0.22 µm	20 - 35 ml/min/cm ²
0.45 µm	45 - 75 ml/min/cm ²

Thickness: 0.160 ± 0.040 mm

Materials

Membrane: Hydrophilic Polytetrafluoroethylene (PTFE)
Housing: Polypropylene (PP)

Diameters: 13, 25, 30 mm.

Filtration area

13 mm diameter:	0.92 cm ²
25 mm diameter:	2.98 cm ²
30 mm diameter:	4.90 cm ²

Maximum temperature of use ≤ 130°C

Maximum pressure of work: 87 psi

Connectors

Inlet: Female luer lock
Outlet: Male luer slip

Hold-up volume

13 mm diameter:	< 10 µl
25 mm diameter:	< 30 µl
30 mm diameter:	< 55 µl

Extractables with water < 0.2%

Chemical compatibility: 1 – 14 pH

Reaction to water: hydrophilic

Sterilization: By γ radiation, ethylene oxide or autoclaving at 121°C.

INFORMATION FOR ORDERS. Hydrophilic PTFE syringe filters

	Code	Membrane	Housing	Diameter	Pore	Inlet/Outlet	Format	Quantity
0.22 μm	JPTFL022013N	Hydrophilic PTFE	Polypropylene	13 mm.	0.22 μm	luer lock/luer slip	non sterile	100 units
	JPTFL022013R	Hydrophilic PTFE	Polypropylene	13 mm.	0.22 μm	luer lock/luer slip	non sterile	1000 units
	JPTFL022025N	Hydrophilic PTFE	Polypropylene	25 mm.	0.22 μm	luer lock/luer slip	non sterile	100 units
	JPTFL022025R	Hydrophilic PTFE	Polypropylene	25 mm.	0.22 μm	luer lock/luer slip	non sterile	1000 units
	JPTFL022030N	Hydrophilic PTFE	Polypropylene	30 mm.	0.22 μm	luer lock/luer slip	non sterile	100 units
	JPTFL022030R	Hydrophilic PTFE	Polypropylene	30 mm.	0.22 μm	luer lock/luer slip	non sterile	1000 units
0.45 μm	JPTFL045013N	Hydrophilic PTFE	Polypropylene	13 mm.	0.45 μm	luer lock/luer slip	non sterile	100 units
	JPTFL045013R	Hydrophilic PTFE	Polypropylene	13 mm.	0.45 μm	luer lock/luer slip	non sterile	1000 units
	JPTFL045025N	Hydrophilic PTFE	Polypropylene	25 mm.	0.45 μm	luer lock/luer slip	non sterile	100 units
	JPTFL045025R	Hydrophilic PTFE	Polypropylene	25 mm.	0.45 μm	luer lock/luer slip	non sterile	1000 units
	JPTFL045030N	Hydrophilic PTFE	Polypropylene	30 mm.	0.45 μm	luer lock/luer slip	non sterile	100 units
	JPTFL045030R	Hydrophilic PTFE	Polypropylene	30 mm.	0.45 μm	luer lock/luer slip	non sterile	1000 units

Polyvinylidene Fluoride (PVDF) syringe filters

Recommended on the filtration of aqueous samples, biological, aggressive solvents or diluted i and gases

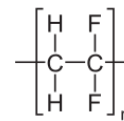

Description

The Polyvinylidene Fluoride (PVDF) is a material that has great properties: high chemical and physical stability, low absorption of proteins, low level of extractables and a perfect pore structure.

Two kinds of PVDF are manufactured: with hydrophilic reaction to water and hydrophobic reaction to water.

The hydrophilic one can be used on the clarification and sterilization of aqueous and biological samples, and in the filtration of aggressive solvents, diluted, alcohols, acids, etc. While the hydrophobic version is appropriated for the filtration of gases, vapors, and also of solvents or samples that does not have an aqueous character.

It is available in a sterile and non sterile format and in 13, 25 and 30mm of diameter, 33 mm of diameter with hydrophobic membrane.

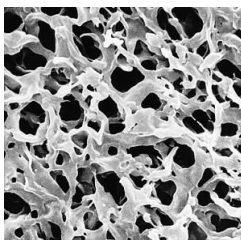

Advantages

- Reaction to water: hydrophilic and hydrophobic (2 versions).
- Non specifically absorption of proteins.
- Low level of extractables.
- Great chemical compatibility in front of a large range of solvents, acids and alcohols.
- Rnase-free certification, Dnase-free certification, DNA-free (free from ADN and ARN).
- Without pyrogenic.

Applications

- Clarification and sterilization of aqueous and biological samples.
- Filtration of samples from aggressive or diluted solvents..
- Control of medicines.
- Filtration of food samples.



TECHNICAL SPECIFICATIONS

Bubble point with alcohol (minimum value)

0.22 µm	1.0 bar 100 Kpa
0.45 µm	0.5 bar 50 Kpa

Flow rate with alcohol (ml/min /cm²) Δp=0.7 bar | 70 Kpa approx.:

0.22 µm	8 ml/min/cm ²
0.45 µm	12 ml/min/cm ²

Thickness: 0.150 – 0.170 mm

Materials

Membrane: Polyvinylidene Fluoride (PVDF)
Housing: Polypropylene (PP)

Diameters: 13, 25, 30 and 33 mm.

Filtration area

13 mm diameter:	0.92 cm ²
25 mm diameter:	2.98 cm ²
30 mm diameter:	4.90 cm ²

Maximum temperature of use: ≤ 100°C

Maximum pressure of work:

13 mm diameter	3,45 bar
25 mm diameter	6,55 bar
30 mm diameter	6,89 bar
33 mm diameter	6,89 bar

Connectors

Inlet: Female luer lock
Outlet: Mal luer slip

Hold-up volume

13 mm diameter:	< 10 µl
25 mm diameter:	< 30 µl
33 mm diameter:	< 55 µl

Extractables with water < 0.2%

Chemical compatibility: 1 – 14 pH

Reaction to water: hydrophilic/hydrophobic

Absorption: Low non-specific absorption of proteins

INFORMATION FOR ORDERS. Hydrophilic polyvinylidene polyfluoride syringe filters(PVDF)

Applications: Filtration of aqueous, biological samples, pure or diluted solvents

	Code	Membrane	Wettability	Housing	Diameter	Pore	Inlet/Outlet	Format	Quantity
0.22 µm	JPV022013N	PVDF	hydrophilic	Polypropylene	13 mm.	0.22 µm	luer lock/luer slip	non sterile	100 units
	JPV022013R	PVDF	hydrophilic	Polypropylene	13 mm.	0.22 µm	luer lock/luer slip	non sterile	1000 units
	JPVS022025K	PVDF	hydrophilic	Polypropylene	25 mm.	0.22 µm	luer lock/luer slip	sterile, ind.	50 units
	JPV022025N	PVDF	hydrophilic	Polypropylene	25 mm.	0.22 µm	luer lock/luer slip	non sterile	100 units
	JPV022025R	PVDF	hydrophilic	Polypropylene	25 mm.	0.22 mm	luer lock/luer slip	non sterile	1000 units
	JPV022030N	PVDF	hydrophilic	Polypropylene	30 mm.	0.22 mm	luer lock/luer slip	non sterile	100 units
0.45 µm	JPV045013N	PVDF	hydrophilic	Polypropylene	13 mm.	0.45 µm	luer lock/luer slip	non sterile	100 units
	JPV045013R	PVDF	hydrophilic	Polypropylene	13 mm.	0.45 µm	luer lock/luer slip	non sterile	1000 units
	JPVS045025K	PVDF	hydrophilic	Polypropylene	25 mm.	0.45 µm	luer lock/luer slip	sterile, ind.	50 units
	JPV045025N	PVDF	hydrophilic	Polypropylene	25 mm.	0.45 µm	luer lock/luer slip	non sterile	100 units
	JPV045025R	PVDF	hydrophilic	Polypropylene	25 mm.	0.45 mm	luer lock/luer slip	non sterile	1000 units
	JPV045030N	PVDF	hydrophilic	Polypropylene	30 mm.	0.45 mm	luer lock/luer slip	non sterile	100 units
JPV045030R	PVDF	hydrophilic	Polypropylene	30 mm.	0.45 mm	luer lock/luer slip	non sterile	1000 units	

INFORMATION FOR ORDERS. Hydrophobic polyvinylidene polyfluoride syringe filters(PVDF)

Applications: Filtration of samples with pure or diluted solvents, filtration of gases, vapors, etc.

	Code	Membrane	Wettability	Housing	Diameter	Pore	Inlet/Outlet	Format	Quantity
0.22 µm	JPVFB022013N	PVDF	hydrophobic	Polypropylene	13 mm.	0.22 µm	luer lock/luer slip	non sterile	100 units
	JPVFB022013R	PVDF	hydrophobic	Polypropylene	13 mm.	0.22 µm	luer lock/luer slip	non sterile	1000 units
	JPVFB022025N	PVDF	hydrophobic	Polypropylene	25 mm.	0.22 µm	luer lock/luer slip	non sterile	100 units
	JPVFB022025R	PVDF	hydrophobic	Polypropylene	25 mm.	0.22 µm	luer lock/luer slip	non sterile	1000 units
	JPVFB022030N	PVDF	hydrophobic	Polypropylene	30 mm.	0.22 µm	luer lock/luer slip	non sterile	100 units
	JPVFB022030R	PVDF	hydrophobic	Polypropylene	30 mm.	0.22 µm	luer lock/luer slip	non sterile	1000 units
0.45 µm	JPVFB045013N	PVDF	hydrophobic	Polypropylene	13 mm.	0.45 µm	luer lock/luer slip	non sterile	100 units
	JPVFB045013R	PVDF	hydrophobic	Polypropylene	13 mm.	0.45 µm	luer lock/luer slip	non sterile	1000 units
	JPVFB045025N	PVDF	hydrophobic	Polypropylene	25 mm.	0.45 µm	luer lock/luer slip	non sterile	100 units
	JPVFB045025R	PVDF	hydrophobic	Polypropylene	25 mm.	0.45 µm	luer lock/luer slip	non sterile	1000 units
	JPVFB045030N	PVDF	hydrophobic	Polypropylene	30 mm.	0.45 µm	luer lock/luer slip	non sterile	100 units
	JPVFB045030R	PVDF	hydrophobic	Polypropylene	30 mm.	0.45 µm	luer lock/luer slip	non sterile	1000 units

Polypropylene syringe filters (PP)

Preparation of aqueous and organic samples in HPLC with high particle content

Description

FILTER-LAB® Polypropylene Syringe filters (PP) have their main application in the preparation of aqueous and organic samples, but specially in HPLC dense samples. Its elevated purity guarantees that do not appear weird results on the assays.

Likewise, its excellent resistance and hydrophilic behavior permit its use in aqueous and organic samples.

This kind of filters has raised during its fabrication process a lot of integrity tests with elevated levels of pressure in work.

Our filters are available in non-sterile format and in 13 and 25 mm diameter with 0.22 and 0.45 µm membrane.

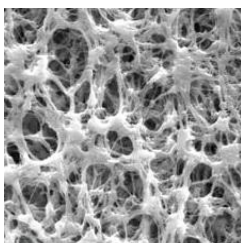

Advantages

- Hydrophilic reaction to water
- Very low absorption nonspecifically in proteins.
- Extractable low level.
- Great chemical compatibility in front of a big number of solvents
- Certified Guarantee in its use with aqueous and organic samples in HPLC.
- Without pyrogenic.



Applications

- Preparation of aqueous and organic samples in HPLC.
- Filtration and clarification of organic solvents.
- Filtration of samples on culture media.
- Refractometry

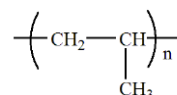

TECHNICAL SPECIFICATIONS

Bubble point with alcohol (minimum value)

0.22 µm	2.8 bar 280 Kpa
0.45 µm	1.6 bar 160 Kpa

Flow rate with alcohol (ml/min /cm²) Δp= 0.7 bar | 70 Kpa aprox.:

0.22 µm	60 ml/min/cm ²
0.45 µm	140 ml/min/cm ²

Thickness: 0.170 – 0.200 mm

Materials

Membrane: Polypropylene (PP)
Housing: Polypropylene (PP)

Diameters: 13, 25 mm.

Filtration area

13 mm diameter:	0.92 cm ²
25 mm diameter:	2.98 cm ²

Maximum temperature of use: 50°C

Maximum pressure of work:

13 mm diameter	50 psi
25 mm diameter	50 psi

Connectors

Inlet: Female luer lock
Outlet: Male luer slip

Hold-up volume

13 mm diameter:	< 10 µl
25 mm diameter:	< 30 µl

Extractables with water < 0.2%

Chemical compatibility: 1 – 14 pH

Reaction to water: hydrophilic.

Absorption: Low non-specific adsorption in proteins.

INFORMATION FOR ORDERS. Polypropylene (PP) syringe filters

	Code	Membrane	Housing	Diameter	Pore	Inlet/Outlet	Format	Quantity
0.22 μm	JPP022013N	Polypropylene	Polypropylene	13 mm.	0.22 μm	luer lock/luer slip	non sterile	100 units
	JPP022013R	Polypropylene	Polypropylene	13 mm.	0.22 μm	luer lock/luer slip	non sterile	1000 units
	JPP022025N	Polypropylene	Polypropylene	25 mm.	0.22 μm	luer lock/luer slip	non sterile	100 units
	JPP022025R	Polypropylene	Polypropylene	25 mm.	0.22 μm	luer lock/luer slip	non sterile	1000 units
0.45 μm	JPP045013N	Polypropylene	Polypropylene	13 mm.	0.45 μm	luer lock/luer slip	non sterile	100 units
	JPP045013R	Polypropylene	Polypropylene	13 mm.	0.45 μm	luer lock/luer slip	non sterile	1000 units
	JPP045025N	Polypropylene	Polypropylene	25 mm.	0.45 μm	luer lock/luer slip	non sterile	100 units
	JPP045025R	Polypropylene	Polypropylene	25 mm.	0.45 μm	luer lock/luer slip	non sterile	1000 units

Regenerated cellulose syringe filters

Filtration of aqueous samples, solvents and mobile phases

Description

FILTER-LAB® regenerated cellulose syringe (RC) filters have a hydrophilic membrane and are also solvent-resistant, including acetonitrile.

Also, its excellent resistance and hydrophilic behavior allow it to be used in aqueous and organic samples.

Used in the filtration of samples for HPLC, mobile phases or the clarification of solvents.

They are available in non-sterile format and in 13 and 25 mm diameter with 0.22 and 0.45 µm pore membrane.

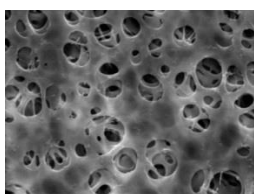

Advantages

- Reaction to hydrophilic water.
- Low non-specific adsorption of proteins.
- Low level of extractables.
- Good chemical compatibility with many solvents, including acetonitrile.

Applications

- Preparation of aqueous and organic samples on HPLC.
- Filtration and clarification of organic solvents.
- Filtration of samples of culture media.
- Filtration of mobile phases

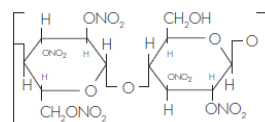

TECHNICAL SPECIFICATIONS

Bubble point with alcohol (minimum value)

0.22 µm	4.4 bar Kpa
0.45 µm	2.8 bar Kpa

Flow rate with alcohol (ml/min /cm²) Δp= 0.7 bar | 70 Kpa aprox.:

0.22 µm	16 ml/min/cm ²
0.45 µm	28 ml/min/cm ²

Thickness : 0.160 mm

Materials

Membrane: Regenerated Cellulose (RC)
Housing: Polypropylene (PP)

Diameters : 13, 25 mm.

Filtration area

13 mm diameter:	0.92 cm ²
25 mm diameter:	2.98 cm ²

Maximum temperature of use: 120°C

Maximum pressure of work:

13 mm diameter	87 psi
25 mm diameter	87 psi

Connectors

Inlet: Female luer lock
Outlet: Male luer slip

Hold-up volume

13 mm diámetro:	< 10 µl
25 mm diámetro:	< 150 µl

Recommended sample volumen

13 mm diameter:	< 10 ml
25 mm diameter:	< 80 ml

Extractables with water < 1%

Chemical compatibility : 3 - 12 pH

Reaction to water: hydrophilic

Absorption: Low non-specific adsorption in proteins:
< 10 µg/cm²

Sterilization: Autoclave at 121°C or 134°C, γ radiation,
dry heat at 180°C, ethylene oxide or γ radiation

INFORMATION FOR ORDERS. Regenerated Cellulose (RC) syringe filters

	Code	Membrane	Housing	Diameter	Pore	Inlet/Outlet	Format	Quantity
0.22 μm	JRC022013N	Regenerated cel.	Polypropylene	13 mm.	0.22 μm	luer lock/luer slip	non sterile	100 units
	JRC022013R	Regenerated cel.	Polypropylene	13 mm.	0.22 μm	luer lock/luer slip	non sterile	1000 units
	JRC022025N	Regenerated cel.	Polypropylene	25 mm.	0.22 μm	luer lock/luer slip	non sterile	100 units
	JRC022025R	Regenerated cel.	Polypropylene	25 mm.	0.22 μm	luer lock/luer slip	non sterile	1000 units
0.45 μm	JRC045013N	Regenerated cel.	Polypropylene	13 mm.	0.45 μm	luer lock/luer slip	non sterile	100 units
	JRC045013R	Regenerated cel.	Polypropylene	13 mm.	0.45 μm	luer lock/luer slip	non sterile	1000 units
	JRC045025N	Regenerated cel.	Polypropylene	25 mm.	0.45 μm	luer lock/luer slip	non sterile	100 units
	JRC045025R	Regenerated cel.	Polypropylene	25 mm.	0.45 μm	luer lock/luer slip	non sterile	1000 units

Accessories for syringe filters

Dispenser pistol, syringes and needles



Dosing syringe

Dosage system, in combination with our syringe filters, for a quick filtration and dosage. Is very recommended for the humidification of dehydrated culture media in laboratories of microbiological analyses.

The dosage volume can be adjusted infinitely between 0.5 and 5.0 ml, just twirling the screw's handle. The dispenser is very easy to use and avoids the tiredness in the hand after long use.

3 Valve 3 Tract

Permits the filtration in continue

One use syringe

Connection adapted to luer lock syringe filter.

Needles

Can be connected to the output's syringe filter. The stainless steel needles can be used with autoclave.

INFORMATION FOR ORDERS

Dosing syringe

Code	Description
16685-2	Dosing syringe
16639	3 way valve (autoclavable at 121° C)

Syringes

Code	Description
16644E	Volume: 5 ml. Pack of 12 units
16645E	Volume: 10 ml. Pack of 12 units
16646E	Volume: 20 ml. Pack of 12 units
16647E	Volume: 50 ml. Pack of 12 units

Interchange parts

Code	Description
6986070	Sealing gasket. 4 units
6986071	Pressure spring. 2 units
6986072	Fixing spring. 2 units
6986073	Valve. 2 units

Needles

Code	Description
01324	Stainless steel needles
01325	Single-use needles

Filtration vials

Rapid preparation of aqueous and organic samples for HPLC.
Can replace syringe filters



Description

These small FILTER-LAB filtration vials are made up of 2 parts: one of them is a piston-shaped cylinder in the lower part of which is embedded a membrane and in its upper part a plug with a septum to puncture the sample with the syringe. The other part is an open cylinder on one side. Pressing fit and pressing these two pieces the sample crosses the membrane and is filtered and prepared to be analyzed.

They are available with membranes of PTFE, Nylon and PVDF with pore of 0.2 and 0.45 μm .

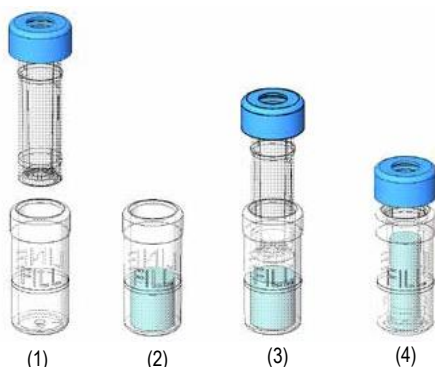

- (1) Separation of parts
- (2) Filling the cylinder
- (3) Pressure and filtration movement
- (4) Sample ready

TECHNICAL SPECIFICATIONS

Dimensions: 12 mm diameter x 33 mm height

Materials: Polypropylene, Septa, PTFE and silicone

Sample capacity: 0.48 ml

Filtration capacity: 0.45 ml

Hold-up volume: 0.03 ml

Pressure required for filtration : 8 psi (0.6 bar)

Maximum temperature of use: 50°C

Membrane material: PTFE, Nylon or PVDF.

Advantages

- Rapid preparation of samples
- Filter with a plunger in the vial reduces sample loss
- After the sample filtration is ready to use in the self-sampler robot
- The capsule slot ensures easy and clean transfer to the syringe
- Compatible with most standard auto-samplers

Applications

PTFE

- Filtration of strong acids and aggressive leaks.
- Drug metabolite studies
- Clarification of aqueous samples and organic solvents.
- Sample preparation for HPLC
- Chromatography.

PVDF

- Biological studies
- Clarification studies
- Dissolution tests

NYLON

- Clarification of aqueous solutions and organic solvents
- Preparation of samples for HPLC.
- Chromatography

INFORMATION FOR ORDERS. Filtration vials

	Code	Membrane	Housing	Capacity	Pore	Color	Quantity
0.2 μm	FVPT020N	Hydrophilic PTFE	Polypropylene	0.48 ml	0,2 μm	Rose	100 units
	FVNY020N	Nylon	Polypropylene	0.48 ml	0,2 μm	Soft blue	100 units
	FVPV020N	Hydrophilic PVDF	Polypropylene	0.48 ml	0,2 μm	Yellow	100 units
0.45 μm	FVPT045N	Hydrophilic PTFE	Polypropylene	0.48 ml	0,45 μm	Red	100 units
	FVNY045N	Nylon	Polypropylene	0.48 ml	0,45 μm	Blue	100 units
	FVPV045N	Hydrophilic PVDF	Polypropylene	0.48 ml	0,45 μm	Orange	100 units

Chemical compatibility for syringe filters

Solvents	Cel. Acetate	Glass fiber	PP	Polyamide	PTFE	PES	PVDF	Reg. Cel.	Polyester	PC
Lubricant oil	?	✓	✓	✓	✓	×	✓	✓	✓	✓
Peanut oil	?	✓	✓	✓	✓	✓	✓	?	✓	✓
Cotton seed oil	?	✓	✓	✓	✓	?	✓	?	?	?
Sesame oil	?	✓	✓	✓	✓	✓	✓	?	✓	✓
Acetone	×	✓	✓	✓	✓	×	□	✓	✓	□
Acetonitrile	×	?	□	□	✓	✓	✓	✓	?	×
Ethyl alcohol 90%	✓	✓	✓	✓	✓	✓	?	?	✓	✓
Amyl alcohol	✓	✓	✓	✓	✓	✓	✓	✓	?	?
Benzyl alcohol	?	✓	✓	✓	✓	×	×	✓	×	×
Water	✓	✓	✓	✓	*	✓	✓	✓	✓	✓
Amyl acetate	×	?	?	□	✓	?	✓	✓	✓	✓
Aniline	?	?	□	□	✓	×	✓	?	✓	×
Benzene	×	✓	×	□	✓	✓	□	✓	✓	□
N-Butyl acetate	×	✓	□	□	✓	?	✓	✓	✓	✓
N-Butanol	□	✓	✓	✓	✓	✓	✓	✓	✓	✓
Cellosolve	×	✓	✓	?	✓	✓	✓	✓	✓	✓
Chloroform	×	✓	□	□	✓	×	□	✓	✓	×
Cyclohexane	×	✓	✓	?	✓	×	?	✓	✓	✓
Cyclohexanane	×	✓	✓	?	✓	×	□	✓	?	□
Methylene Chloride	×	✓	✓	✓	✓	×	✓	□	×	×
Dichloroethylene	□	✓	□	□	✓	×	□	✓	✓	×
Methylene Chloride	×	?	□	×	✓	×	□	✓	×	×
Dimethylacetamide	×	✓	×	✓	✓	?	?	✓	×	×
Diethyl ether	?	✓	✓	✓	✓	?	✓	✓	✓	✓
Dimethylformamide	×	✓	✓	✓	✓	×	×	□	×	×
Dimethyl sulfoxide	×	✓	✓	✓	✓	×	×	✓	✓	×
Dioxane	×	?	✓	✓	✓	✓	✓	✓	✓	×
Ethanol 98%	×	✓	✓	✓	✓	✓	✓	✓	✓	✓
Ethyl acetate	×	?	□	□	✓	□	✓	✓	?	?
Ethyl ether	□	?	✓	×	✓	✓	✓	✓	✓	✓
Ethylene glycol	?	✓	✓	✓	✓	□	✓	✓	✓	✓
Phenol	✓	?	✓	✓	✓	×	✓	✓	✓	?
Formamide	?	✓	✓	?	✓	?	?	?	×	?
Formaldehyde 37%	?	?	✓	✓	✓	✓	✓	□	✓	✓
Gasoline	✓	✓	□	□	□	?	□	✓	✓	✓
Glicerina	✓	✓	✓	✓	✓	□	✓	✓	✓	✓
n-Heptano	✓	✓	✓	✓	✓	✓	✓	✓	✓	?
n-Hexano	✓	✓	✓	✓	✓	✓	✓	✓	✓	✓
Isobutanol	□	✓	?	✓	✓	?	?	✓	?	✓
Isopropanol	□	✓	✓	✓	✓	✓	✓	✓	✓	✓
Isopropil acetato	□	✓	✓	?	✓	✓	✓	✓	✓	?
Isopropil éter	×	?	✓	?	✓	?	✓	?	✓	?
Keroseno	✓	✓	✓	?	✓	✓	✓	✓	✓	✓
Metanol 98%	×	✓	✓	?	✓	✓	✓	✓	?	✓
Metil acetato	×	?	✓	□	✓	×	✓	✓	✓	?
Metil etil cetona	×	✓	✓	□	✓	?	□	✓	✓	?
Metil isobutil cetona	?	✓	✓	□	✓	×	□	✓	?	?
Monoclorobenzeno	?	✓	?	✓	✓	?	?	✓	?	×
Niquel sulfato	?	✓	✓	✓	✓	?	✓	?	?	?

Solvents	Cel. Acetate	Glass fiber	PP	Polyamide	PTFE	PES	PVDF	Reg. Cel.	Polyester	PC
Nitrobenzene	?	✓	✓	✓	✓	?	?	✓	×	×
N-Pentane	✓	✓	□	✓	✓	?	✓	✓	✓	✓
Perchloroethylene	□	✓	□	?	✓	□	□	✓	?	?
Pyridine	×	✓	□	□	✓	×	✓	✓	✓	×
Perchloroethylene	□	✓	□	?	✓	□	□	✓	?	?
Pyridine	×	✓	□	□	✓	×	✓	✓	?	✓
Propylene glycol	?	?	✓	✓	✓	□	✓	?	?	?
Carbon tetrachloride	□	✓	□	□	✓	□	□	✓	?	?
Tetrahydrofuran	×	✓	□	×	✓	×	□	✓	?	×
Toluene	×	✓	×	×	✓	×	□	✓	✓	□
Turpentine	?	?	□	?	✓	✓	✓	?	✓	✓
Trichloroethane	□	✓	✓	✓	✓	?	?	✓	?	?
Trichloroethylene	?	✓	□	□	✓	□	×	✓	?	×
Xylene	×	✓	×	□	✓	×	□	✓	×	✓

Ácidos	Acetato cel.	Fibra vidrio	PP	Poliamida	PTFE	PES	PVDF	Cel. Reg.	Poliester	PC
Acetic acid 25%	✓	?	✓	□	✓	×	✓	✓	✓	□
Acetic acid 96%	×	?	✓	×	✓	✓	✓	✓	?	?
Boric acid	✓	?	✓	□	✓	?	?	?	✓	✓
Hydrofluoric acid 25%	✓	×	?	×	✓	?	✓	□	?	?
Hydrofluoric acid 50%	✓	×	×	×	✓	✓	✓	×	?	?
Phosphoric acid 25%	✓	?	?	×	✓	?	✓	□	?	?
Phosphoric acid 85%	×	?	✓	×	✓	?	✓	×	?	×
Nitric acid 25%	×	?	✓	×	✓	?	✓	×	✓	✓
Nitric acid 65%	×	?	✓	×	✓	?	✓	×	×	✓
Hydrochloric acid 25%	×	?	✓	×	✓	✓	✓	×	□	✓
Hydrochloric acid 37%	×	?	✓	×	✓	✓	✓	×	×	✓
Sulfuric acid 25%	×	✓	?	×	✓	✓	✓	□	✓	?
Sulfuric acid 98%	×	×	✓	×	✓	×	?	×	×	×
Trichloroacetic Acid 25%	×	?	?	×	✓	?	?	✓	?	?

Bases	Cel. Acetate	Glass fiber	PP	Polyamide	PTFE	PES	PVDF	Reg. Cel.	Polyester	PC
Ammonia, 1N	✓	✓	?	✓	✓	✓	?	□	□	×
Ammonium hydroxide 25%	□	□	✓	✓	✓	✓	□	×	□	×
Ammonium hydroxide (3N)	×	?	✓	✓	✓	✓	□	?	×	×
Potassium Hydroxide 32%	×	?	✓	✓	✓	✓	□	□	×	×
Sodium hydroxide 32%	×	□	✓	✓	✓	✓	□	□	×	×
Sodium hydroxide (6N)	□	✓	✓	✓	✓	✓	×	□	×	×

Aqueous Solutions	Cel. Acetate	Glass fiber	PP	Polyamide	PTFE	PES	PVDF	Reg. Cel.	Polyester	PC
Formamide 30%	?	✓	?	□	✓	✓	✓	?	?	✓
Sodium Hypochlorite 5%	✓	✓	?	□	✓	?	?	✓	?	?
Hydrogen peroxide 35%	✓	?	?	□	✓	?	?	□	?	?

Symbols

- ✓ = compatible □ = limited compatibility
 × = not compatible ? = not tested

Time of contact: 24 hours to 20°C

Chemical compatibility depends of several factors

For that, recommend confirm the compatibility with the sample before to start the process of filtration

Polycarbonate filter-holder 13 mm diameter

Filtration of aqueous samples with small volume



Description

Great quality filter-holder made of transparent polycarbonate. It can be used with autoclave. It also has a silicone gasket to avoid a leak of liquid. It can be decrease with pressures till 7 bar and it can be filtered in both directions.

Advantages

- Low hold-up volume
- Easy to clean
- Sterilizable at 121°C

Applications

- Filtration of small aqueous samples

INFORMATION FOR ORDERS. Polycarbonate filter-holder 13 mm diameter

Code	Description
16514E-2	Polycarbonate filter-holder. 13 mm diameter. Pack 2 units
16514E	Polycarbonate filter holder. 13 mm diameter. Pack 12 units
6980569	Replacement silicone gasket . Bag 10 units

TECHNICAL SPECIFICATIONS

Connectors

Inlet Female Luer lock
 Outlet Male luer slip

Flow rate with water (ml/min /cm²) Δp= 1 bar | 100 Kpa aprox.:

0.22 μm membrane 18 ml/min aprox.
 0.45 μm membrane 35 ml/min aprox.

Chemical compatibility: The same as polycarbonate and silicone

Materials: Polycarbonate (housing) and silicone (flat gasket)

Diameter: 13 mm

Filtration area: 0.5 cm²

Weight: 13 g

Max. pressure: 7 bar (700 kPa, 101,57 psi)

Membrane filter measure: 13 mm diameter

Hold-up volume

< 0.2 ml after reaching bubble point, 0.3 ml before

Sterilization: Autoclaving (max. 121°C)

PTFE filter-holder 13 mm diameter

Filtration of samples from aggressive products with a small volume



Description

The filter-holder made of PTFE for the ultra cleaning of little volumes (more than 10 ml aprox.). The PTFE is an inert material that does not give retains of elements, and for that reason is very adequate on the elimination of particles in little samples of aggressive products.

This filter-holder does not have a dryer ring, for this reason the torsion of the superior membrane is avoided, this membrane is avoided when the base is strengthened.

Advantages

- Amazing resistance to aggressive solvents
- Low dead volume
- Easy to clean
- Dry at 180°C
- Can be sterile

Applications

- Filtration of little volumes of samples, aggressive solvents and every kind of liquids.

INFORMATION FOR ORDERS. PTFE filter-holder 13 mm diameter

Cod.	Description
16574	PTFE filter holder 13 mm diameter

TECHNICAL SPECIFICATIONS

Connectors

Inlet Female Luer lock
 Outlet Male luer slip

Flow rate with water (ml/min /cm²) Δp= 1 bar | 100 Kpa aprox.:

0.22 μm membrane 10 ml/min aprox.
 0.45 μm membrane 18 ml/min aprox.

Chemical compatibility: Same as PTFE

Materials: PTFE

Diameter: 13 mm

Filtration area: 0.5 cm²

Weight: 13 g

Maximum pressure: 5 bar (500 kPa, 72.5 psi)

Membrane filter measure: 13 mm diameter

Hold-up volume

< 0.03 ml after reaching bubble point, 0.3 ml before

Sterilization: Autoclaving (max. 134°C) or dry heat (max. 180°C)

Polycarbonate filter-holder 25 mm diameter

Filtration of aqueous samples



Description

Filter-holder made of transparent polycarbonate. It can be use with autoclave. A silicone gasket avoids the leak of liquid. This filter-holder can be use with pressures till 7 bar, It is used as habitual on the filtration of aqueous samples. It works with membranes of 25 mm diameter.

Advantages

- Low dead volume
- Easy to clean
- Sterile at 121°C

Applications

- Filtration of aqueous samples

INFORMATION FOR ORDERS. Polycarbonate filter-holder 25 mm diameter

Cod.	Description
16517E	Polycarbonate filter-holder 25 mm diameter. Pack 12 units
16517E-2	Polycarbonate filter-holder 25 mm diameter. Pack 2 units
1EDS-D0055	Silicone gasket replacement. Bag 10 units

TECHNICAL SPECIFICATIONS

Connectors

Inlet Female luer lock
 Outlet Male luer slip

Flow rate with water (ml/min /cm²) Δp= 1 bar | 100 Kpa aprox.:

0.22 μm membrane 70 ml/min aprox.
 0.45 μm membrane 110 ml/min aprox.

Chemical compatibility: The same as the polycarbonate and silicone

Materials: Polycarbonate in the pieces and silicone in the gasket (20.5 x 26.5 mm)

Diameter: 25 mm

Filtration area: 3 cm²

Maximum pressure: 7 bar (700 kPa, 101,57 psi)

Dimensions of membrane filter: 25 mm diameter

Hold-up volume

< 0.3 ml before reaching the point of bubble 0.6 ml before

Sterilization: Autoclaving (max. 121°C)

Stainless steel filter-holder 25 mm diameter

Filtration of samples with solvents and chemical products



Description

Filter-holder made of stainless steel to use with solvents and chemical products. The surface of the top part is wrapped with PTFE, this material guarantees the stands without necessity of gasket, for this reason the resistance to warm its higher. The chemical compatibility depends on the introduced filter. The filtration can be done in both senses.

Advantages

- High chemical compatibility
- Easy to clean
- Sterilizable at 121°C
- Gasket not needed

Applications

- Filtration of aqueous samples, solvents and chemical products

INFORMATION FOR ORDERS. Stainless Steel filter-holder 25 mm diameter

Cod.	Description
16214	25 mm stainless steel filter holder
6980595	Sealcoal

TECHNICAL SPECIFICATIONS

Connectors

Inlet Female luer lock
 Outlet Male luer slip

Flow rate with water (ml/min /cm²) Δp= 1 bar | 100 Kpa aprox.:

0.22 μm membrane 45 ml/min aprox.
 0.45 μm membrane 80 ml/min aprox.

Chemical compatibility: the same than the stainless steel and PTFE.

Materials: stainless steel (1.4305) pieces superior and inferior. PTFE in the wrapping zone in the superior piece. Luran 368R in the pressure zone of the pieces.

Diameter: 25 mm

Filtration area: 3 cm²

Maximum pressure: 7 bar (700 kPa, 101,57 psi)

Membrane filter dimensions: 25 mm diameter

Hold-up volume

< 0.1 ml before reaching the point of bubble , 0.3 ml before.

Sterilization: Autoclaving (max. 134°C) or dry heat (max. 180°C).

Stainless steel filter holder 25 mm diameter

Filtration of liquids on industrial production lines



Description

Made of stainless steel and used in continue in industrial production in lines. Input and output connections for 10 mm de diameter hose.

Advantages

- Easy to clean
- Sterilizable at 134°C

Applications

- Filtration of liquids in industrial lines.

INFORMATION FOR ORDERS. Stainless Steel filter-holder 25 mm diameter

Cod.	Description
16251	Stainless steel filter holder 25 mm diameter in line use
6980176	Connector
6981031	Top part
6981032	Base
6981034	Lock-out

TECHNICAL SPECIFICATIONS

Connectors

10 mm diameter hose

Flow rate with water (ml/min /cm²) Δp= 1 bar | 100 Kpa aprox.:

0.22 μm membrane 0.5 l/min aprox.
 0.45 μm membrane 1.0 l/min aprox.

Chemical compatibility: the same as the stainless steel, except the silicone pieces.

Materials: Stainless steel, except the silicone pieces, O-ring (21 x 2 mm) and aluminum locker ring

Diameter: 25 mm

Weight: 170 g

Maximum pressure: 5 bar (500 kPa, 72,5 psi)

Membrane filter dimension: 25 mm diameter

Sterilization: Autoclaving (max. 134°C) or dry heat (max. 180°C)

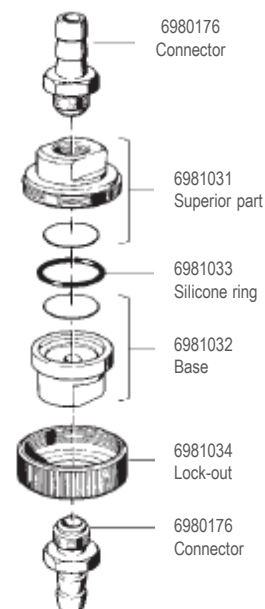

Stainless steel filter-holder 47 mm diameter

Filtration of liquids in lines of industrial production



Description

Made of stainless steel and used in continuous en lines of industrial production. It supports pressures till 20 bar.

It has a lateral exit for the liquid excess.

Must be connected to the 10 mm diameter hose, but accepts G3/8 female connection as an accessory.

Advantages

- Easy to clean
- Sterilizable at 134°C

Applications

- Filtration of liquids in industrial lines

INFORMATION FOR ORDERS. Stainless Steel foilter-holder 47 mm diameter

Cod.	Description
16254	Stainless steel filter-holder 47 mm diameter for filtration in line
6980722	Valve
6980656	Gasket
6980717	Viton o-ring
6982005	Ring's lock
6982003	Top part
6980721	Contrapressure screen
6980178	Silicone ring
6980180	Support screen
6980737	Rack's holder
6982006	Base plaque
6980801	Connector

TECHNICAL SPECIFICATIONS

Connectors

10 mm diameter hose

Flow rate with water (ml/min /cm²) Δp= 1 bar | 100 Kpa aprox.:

0.22 μm membrane 0.5 l/min aprox.
0.45 μm membrane 1.0 l/min aprox.

Chemical compatibility: the same as the stainless steel, except the silicone pieces.

Materials: Stainless steel, except silicone gasket (42 x 3 mm), PTFE and viton in the closing valves.

Diameter: 47 mm

Filtration area: 13 cm²

Weight: 490 g

Maximum pressure: 20 bar (2000 kPa, 190 psi)

Membrane filter dimension: 47 mm diameter

Sterilization: Autoclaving (max. 134°C) or dry hot (max. 180°C)

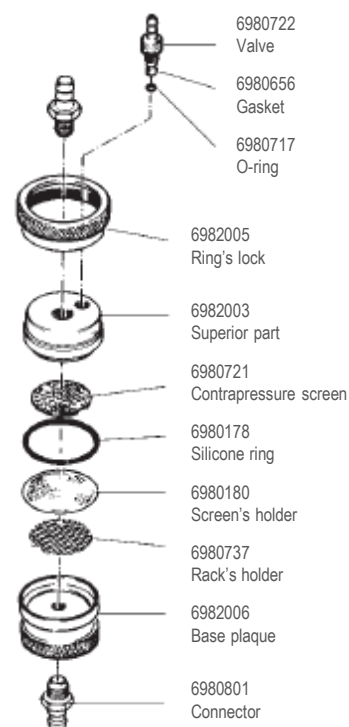

Polycarbonate filter-holder 47 mm diameter

Filtration of samples from different kind of liquids



Description

This filter-holder (47mm diameter) is made of polycarbonate. It is a very practical element in a lot of functions inside the laboratory. It can be connected to a peristaltic bomb or to a pressure gas cylinder. The base has a bell form that protects the liquid contained from any contamination.

Other property is its high pressure resistance; the pieces are transparent for a perfect visualization of the correct sit of the O-ring.

The hose connectors can be replaced for luer connectors to use it as a high surface syringe.

Advantages

- High pressure resistance (7 bar)
- Sterilizable at 121°C
- Transparent to see the O-Ring's sit.

Applications

- Filtration of aqueous samples with a high volume

INFORMATION FOR ORDERS. Polycarbonate filter-holder 47 mm diameter

Cod.	Description
16508B	47 mm diameter polycarbonate filter-holder. Pack 5 units
16508B-1	47 mm diameter polycarbonate filter-holder. Pack 1 unit
6985004	Connector
6980232	Filter holder
6980110	Silicone gasket
6980383	Base

TECHNICAL SPECIFICATIONS

Pressure connectors: 10mm diameter hose

Connectors by nut: M12 x 1 socket nut

Flow rate with water (ml/min /cm²) Δp= 1 bar | 100 Kpa aprox.:

0.22 μm membrane 150 ml/min aprox.
de 0.45 μm membrane 320 ml/min aprox.

Chemical compatibility: the same than the polycarbonate but the silicone pieces.

Materials: Polycarbonate on the top, base and input output connectors. Polypropylene filter-holders. Silicone O-ring (40 x 5 mm).

Diameter: 47 mm

Filtration area: 12.5 cm²

Weight: 83 g

Maximum pressure: 7 bar (700 kPa, 66.5 psi)

Membrane filter, dimensions: 47 - 50 mm diameter

Sterilization: Autoclaving (max. 121°C)

Resistance: The material can support several series but only when the aggressive cleaning agents are cleaned and the water from the boiler does not have anti-corrosive additives..

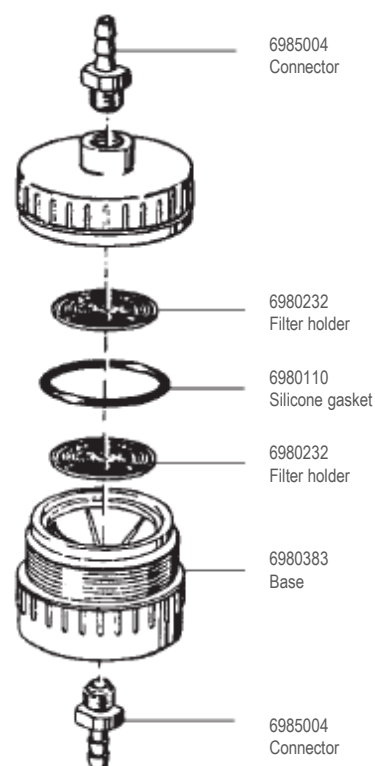

Venting Filters

Sterile ventilation and pump protection in vacuum systems



Description

Filtration units for the sterile ventilation of small fermenters and containers of culture media. It has an inside diameter of 6.12 mm in diameter and incorporates a hydrophobic PTFE membrane reinforced with polypropylene to withstand pressures of 3 bar (43.5 psi).

Its 20 cm² of filtration surface guarantees a high flow with low pressure differential.

Each unit is printed with the lot number and a unit number for total traceability and safety. Units for sterile ventilation in small containers and bottles.

They are units with cirilite shell with membrane of PTFE of 0.2 µm reinforced with polyester. It has luer lock connections.

INFORMATION FOR ORDERS. Venting filters

Pipe connection

Cod.	Description
17804 E	0.45 µm, sterile, individual. Pack 12 units
17804 G	0.45 µm, sterile, individual. Pack 25 units
17805 E	0.2 µm, sterile, individual. Pack 12 units
17805 G	0.2 µm, sterile, individual. Pack 25 units
17805 UPN	0.2 µm, non sterile. Pack 100 units

1/8" NPT male connection

Cod.	Description
17804 NPE	0.45 µm, sterile, individual. Pack 12 units
17804 NPG	0.45 µm, sterile, individual. Pack 25 units
17805 NPE	0.2 µm, sterile, individual. Pack 12 units
17805 NPG	0.2 µm, sterile, individual. Pack 25 units

HY units

Cod.	Description
16596 HYK	sterile, individual. Pack 50 units
16596 HYQ	Non sterile. Pack 500 units

Aplicaciones

- Ventilación estéril de pequeños fermentadores y contenedores de medios de cultivo.
- Protección de bombas de vacío en sistemas de filtración de líquidos.

TECHNICAL SPECIFICATIONS

Connectors: Different types of conical connectors to hose 6-12 mm inside diameter suitable for luer syringes or 1/8 "NPT male connection.

Biological Safety: All plastic materials have passed the USP Class VI test.

Bubble point

0.2 µm membrane 1.4 bar (140 kPa, 20.3 psi)
1.1 after autoclave

0.45 µm membrane 0.9 bar (90 kPa, 13 psi)

Air flow:

Standard values for 0.2µm membranes:

1.1 l/min a 0.02 bar

2.0 l/min a 0.05 bar

5.0 l/min a 0.1 bar

Standard values for 0.45µm membranes :

1.8 l/min a 0.02 bar

4.6 l/min a 0.05 bar

8.5 l/min a 0.1 bar

Filtration area: 20 cm²

Filling volume: Aprox. 3 ml.

Housing diameter: 62 mm

Materials:

Membrane: PTFE reinforced with polypropylene mesh.

Housing: Polypropylene

Maximum temperature of use: 134°C

Sterilization methods:

By autoclaving at 121 ° C (at least 20 times) or 134 ° C.

Models E and G are pre-sterilized with ethylene oxide.

Hold-up volume: Approx. 0.5 ml after the bubble point. 1 ml before.

Water penetration point:

0.2 µm membrane: 4.0 bar (58 psi)

0.45 µm membrane: 3.0 bar (43.5 psi)

Vacuum filtration units

Equipment with incorporated membrane ready to use



Description

FILTER-LAB® filtration units are ready to use equipment that incorporate a polyethersulfone membrane (PES) or Polyvinylidene Fluoride (PVDF) of 0.22 or 0.45 μ m. The received flasks and funnels have three different sizes, 250, 500 and 1000 ml, all graduated. The diameter of the membrane is 50 mm in units 250 and 500 ml and 90 mm diameter larger capacity units. The housing is made of polyethylene and polystyrene. Each unit has a plug to seal the bottle receiver. The polyethersulfone (PES) and the Polyvinylidene Fluoride (PVDF) are materials with high flow rate, very low non-specific adsorption of proteins and low extractable. They are used in the filtration of high volume samples as tissue culture, biological fluids, aqueous solutions, etc..



TECHNICAL SPECIFICATIONS

Materials

Membrane: Polyethersulfone (PES) or PVDF
Housing: Polyethylene (adapter neck) and polystyrene (receiver funnel and flask).

Membrane's diameter: 50, 90 mm.

Funnel's capacity: 250 or 500 ml

Receptor's flask capacity: 250, 500 or 1000 ml

Pore size: 0.22 y 0.45 μ m

Filtration area

50 mm diameter: 17,35 cm²

90 mm diameter: 59,45 cm²

Extractables with water < 1%

Reaction to the membrane's water: hydrophilic

Absorption: Low non-specifically absorption of proteins.

Levels of endotoxins: < 0.25 Eu/ml used 400 cm²/400 ml S.W.F.I. for tests with Limulus Amoebocyte Lysate (LAL)

Advantages

- Wrapped on an individual sterile format.
- Non pyrogenics
- Free of detergent's traces.
- Polyethersulfone membrane (PES)
- 3 different dimensions: 250, 500 and 1000 ml of capacity.
- 2 pores: 0.22 μ m and 0.45 μ m

Applications

- 0.22 μ m: Sterilization of culture media, tampons and biological fluxes.
- 0.45 μ m: Clarification and pre-filtration of solvents and solutions.
- Filtration of solutions that cannot be used with autoclave.

INFORMATION FOR ORDERS. Vacuum filtration units

	Code	Membrane	Diameter	Pore	Funnel cap.	Received flask cap.	Presentation	Quantity
0,22 μm	VFPE022250B	PES	50 mm.	0,22 μm	250 ml	500 ml	sterile, ind.	12 units/pack
	VFPE022500	PES	90 mm.	0,22 μm	500 ml	500 ml	sterile, ind.	12 units/pack
	VFPE022500B	PES	90 mm.	0,22 μm	500 ml	1000 ml	sterile, ind.	12 units/pack
	VFPVDF022250B	PVDF	50 mm.	0,22 μm	250 ml	500 ml	sterile, ind.	12 units/pack
	VFPVDF022500	PVDF	90 mm.	0,22 μm	500 ml	500 ml	sterile, ind.	12 units/pack
	VFPVDF022500B	PVDF	90 mm.	0,22 μm	500 ml	1000 ml	sterile, ind.	12 units/pack
0,45 μm	VFPE045250B	PES	50 mm.	0,45 μm	250 ml	500 ml	sterile, ind.	12 units/pack
	VFPE045500	PES	90 mm.	0,45 μm	500 ml	500 ml	sterile, ind.	12 units/pack
	VFPE045500B	PES	90 mm.	0,45 μm	500 ml	1000 ml	sterile, ind.	12 units/pack
	VFPVDF045250B	PVDF	50 mm.	0,45 μm	250 ml	500 ml	sterile, ind.	12 units/pack
	VFPVDF045500	PVDF	90 mm.	0,45 μm	500 ml	500 ml	sterile, ind.	12 units/pack
	VFPVDF045500B	PVDF	90 mm.	0,45 μm	500 ml	1000 ml	sterile, ind.	12 units/pack

Pumps and vacuum systems

Production for filtration equipment, manifolds and other dispositives

Water jet pump TV-100



Material	Stainless steel
Connection	Male G 3/4

ADVANTAGES

- Simple vacuum tromp for occasional filtrations.

APPLICATIONS

- Occasional filtration with little equipments with one position.

Manueal vacuum pump BV-150



Pump material	PVC
Pressure gauge	yes
Tube (60 cm)	yes
Maximum vacuum	80%

ADVANTAGES

- Vacuum pump made of PVC
- Manometer and 60 cm of tube

APPLICATIONS

- Filtration with individual equipment sporadically or field trials

Vacuum pump BV-300



Parameter	Value
Flow rate	20 l/min
Vacuum regulator	yes
Moisture protector	Yes (plastic)
Inlet	8 mm diámetro
Power	60 W
Voltage	220V/50Hz
Noise level	< 50 dB
Motor rotation	1450 RPM
Dimensions	268 x 135 x 204 mm
Weight	4,1 kg
Head material	Nylon

ADVANTAGES

- Particle and moisture protector
- No maintenance
- Vacuum regulator
- Low noise level
- Thermal protection device
- CE Certificate
- CSA Certificate
- Protection class IP30

APPLICATIONS

- 3-position manifolds or individual filtration equipment

Vacuum pump BV-500



Parameter	Value
Flow rate	34 l/min
Vacuum regulator	yes
Moisture protector	Yes (plastic)
Inlet	8 mm diameter
Power	80 W
Voltage	220V/50Hz
Noise level	< 52.0 dB
Motor rotation	1450 RPM
Dimensions	310 x 135 x 204 mm
Weight	5.2 kg
Heads material	Nylon

ADVANTAGES

- Particle and moisture protector
- No maintenance
- Vacuum regulator
- Low noise level
- Thermal protection device
- CE Certificate
- CSA Certificate
- Protection class IP30

APPLICATIONS

- 6 position manifolds

Pumps and vacuum systems

Production for filtration equipment, manifolds and other dispositives

Vacuum pump BV-1000



Parameter	Value
Flow rate	68 l/min
Vacuum regulator	Yes
Moisture protector	Yes (plastic)
Inlet	10 mm diameter
Power	220 W
Voltage	220V/50Hz
Noise level	< 68.0 dB
Motor rotation	1450 RPM
Dimensions	310 x 135 x 204 mm
Weight	7.9 kg
Heads	2

ADVANTAGES

- Particle and moisture protector
- No maintenance
- Vacuum regulator
- Low noise level
- Thermal protection device
- CE Certificate

APPLICATIONS

- Ramps of 6 positions or multiple systems of several ramps or equipment with high volume of liquid

Vacuum pump BV-411-CR Resistent to chemicals



Parameter	Value
Flow rate	18 l/min
Vacuum regulator	Yes
Moisture protector	Yes (glass)
Inlet	8 mm diameter
Power	90 W
Voltage	220V/50Hz
Noise level	< 50.0 dB
Motor rotation	1450 RPM
Dimensions	262 x 236 x 193 mm
Weight	7.4 kg
Heads	2

ADVANTAGES

- High resistance to aggressive chemicals
- The parts in contact with the liquid are built in PTFE
- No maintenance
- Low noise level
- Thermal protection device
- CE Certificate

APPLICATIONS

- Solvent filtration, solid phase extraction, electrophoresis gel, etc.

Transfer vacuum pump 166MP-4



Parameter	Value
Flow rate	4 l/min
Maximum pressure	1.0 bar
Connections	Quick connect hose 10 mm
Power	160 W
Voltage	100 - 240 V, 50 - 60 Hz
Work temperature	5 - 40°C
Liquid temperature	5 - 80°C
Maximum viscosity	< 150 cSt
Class protection	III
Type protection	IP 64
Dimensions	120 x 170 x 190 mm
Weight	1.7 kg
Materials liquid contact	PTFE, ETFE, PP, EPDM, POM, PSU

This is a new vacuum pump for the transfer of filtrate liquids to the drain. This way it is no longer necessary to use vacuum accessories such as the bottle, tubes, elbows, plugs and connectors, which take up a lot of space. Flow rates are constant and provide a smooth and reliable vacuum

APPLICATIONS

- 3-position or individual filtration equipment.
- Filtration of gases

FILTER-LAB® nylon manifolds

Filtration of samples with physical parameters



Description

Filtration manifold made with polyamide. This manifold is ready to connect glass funnels by a gum or silicone stopper. The vacuum can be regulated with the keys of every position, these keys are made of stainless steel.

It is provided in 1, 3 and 6 branches.

INFORMATION FOR ORDERS. Nylon manifolds

Cod.	Description
RF-NY1	Individual nylon manifold
RF-NY3	3 branches nylon manifold
RF-NY6	6 branches nylon manifold
TS-RNY	Silicone stoppe 1 hole

TECHNICAL SPECIFICATIONS

Materials: Base and ramp funnels base polyamide industrial valve and vacuum connector stainless steel AISI 316

Base of the manifold and the basis of polyamide industrial funnels, valve and AISI 316 stainless steel vacuum connector.

Dimensions in mm (length x width x height):

Single	140 x 180 x 170
3 branches	405 x 180 x 170
6 branches	800 x 180 x 170

Maximum pressure: Vacuum

Sterilization: Autoclaving (max. 134°C),

Water flow at 90% of emptiness: 200 ml/min with membrane filter of 0.2 µm, 600 ml/min with membrane filter of 0.45 µm

Filtration area: 12,5 cm²

Filters diameter: 50 -47 mm diameter

Outlet nozzle: 8-10 mm diameter tube

Individual stainless steel funnels

Microbiological analysis, water and other routine assays

Description

A range of three individual stainless steel funnel with capacity of 40, 100 and 500 ml. Can be used with a glass vial and connect suction through a silicone plug cod. 16606.

This is a very practical and can be sterilized by flaming or autoclaving. There funnel cover, which is graduated within. The frit ensures uniform distribution of the liquid through the entire surface area of the membrane. The clamp ensures a quick connection to the base. All these funnels operated membranes 47 or 50 mm diameter.

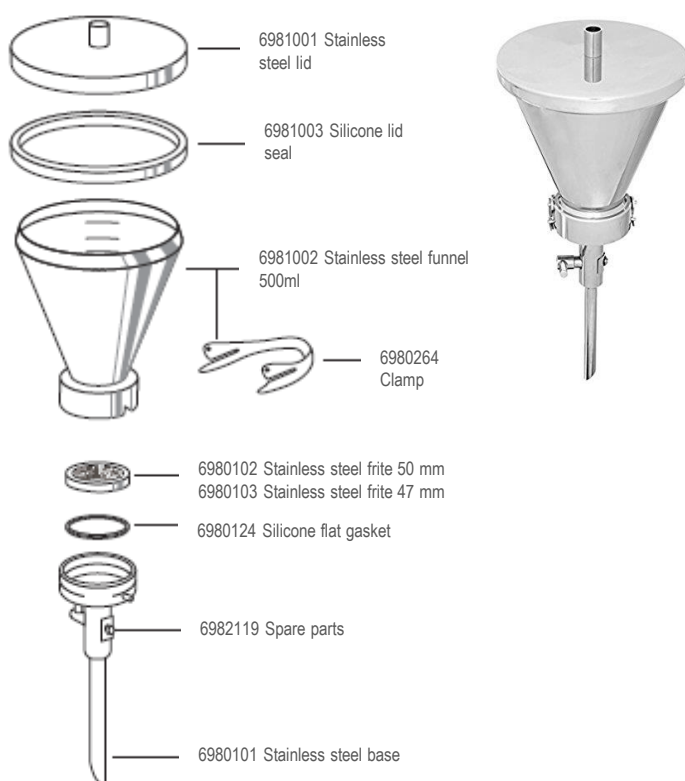

TECHNICAL SPECIFICATIONS

Stainless steel quality: High grade stainless steel B.S. 304S31 / AISI 304

Maximum pressure: Vacuum or maximum 2 bar (29 psi)

Sterilization: Autoclaving (max. 134°C), dry heat (max. 180°C), flamed, other methods according ISO 8199

Parts and materials: Lid, funnel, base, support, clamp and tap made of stainless steel. Silicone flat gasket and silicone lid seal

Flow rate with water to 90% vacuum: 200 ml/min 0.2 µm membrane filter, 600 ml/min 0.45 µm membrane filter.

Filtration area: 12,5 cm²

Diameter filters: 50 -47 mm

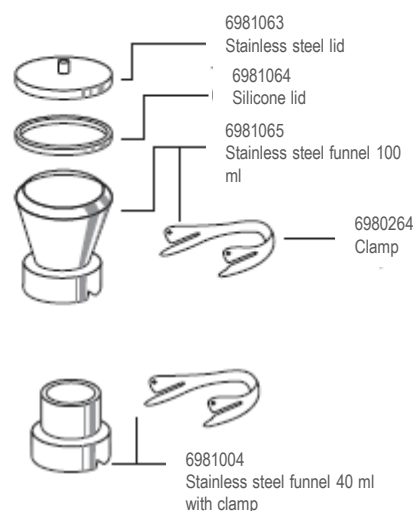

INFORMATION FOR ORDERS. Stainless steel funnels and parts

Cod.	Description
16219	100 ml stainless steel funnel
16201	500 ml stainless steel funnel
16220	40 ml stainless steel funnel

Cod.	Description
6981001	Stainless steel lid for funnel 500 ml
6981003	Silicone lid seal for funnel 500 ml
6981002	Stainless steel funnel 500 ml with clamp
6980264	Funnel clamp
6980102	Stainless steel frit 50 mm
6980103	Stainless steel frit 47 mm
6980124	Silicone flat gasket
6982119	Spare parts
6980101	Stainless steel base
6981063	Stainless steel lid for funnel 100 ml
6981064	Silicone Funnel Seal 100 ml
6981065	Stainless steel funnel 100 ml with clamp
6981004	Stainless steel funnel 40 ml with clamp

Traditional stainless steel manifolds

Laboratories of water, microbiology, soils analyses, etc.



Description

The traditional stainless steel filtration ramps are available with 100 ml or 500 ml funnels and in 3 or 6 branches.

Made of AISI 304 stainless steel.

Every funnel has a lid for open or close the vacuum regarding the analyst's necessity. The stainless steel fritte guaranteed an homogeneous distribution of the particles in the surface of the membrane.

The funnels and holders can be sterilized by flaming, autoclaving, dry heat and other normalized methods.

TECHNICAL SPECIFICATIONS

Stainless steel quality: High quality B.S. 304S31 / AISI 304

Dimensions in mm (length x width x height):

3 x 100 ml:	432 x 184 x 120
3 x 500 ml:	442 x 262 x 132
6 x 100 ml:	906 x 268 x 120
6 x 500 ml:	916 x 329 x 132

Maximum pressure: Vacuum or maximum 2 bar of pressure (29 psi)

Sterilization: Autoclaving (max. 134°C), dry heat (max. 180°C), flame treatment, other methods according to ISO 8199

Parts and materials: lid, funnel, base, stand, clamp and tap made of stainless steel. Flat seal and silicone lid gasket.

Flow rate with water at 90% of vacuum: 200 ml/min with 0.2 µm membrane filter, 600 ml/min with 0.45 µm membrane filter

Filtration area: 12,5 cm²

Filter diameter: 50 -47 mm

Outlet (branches only): hose nipple 10 mm diameter

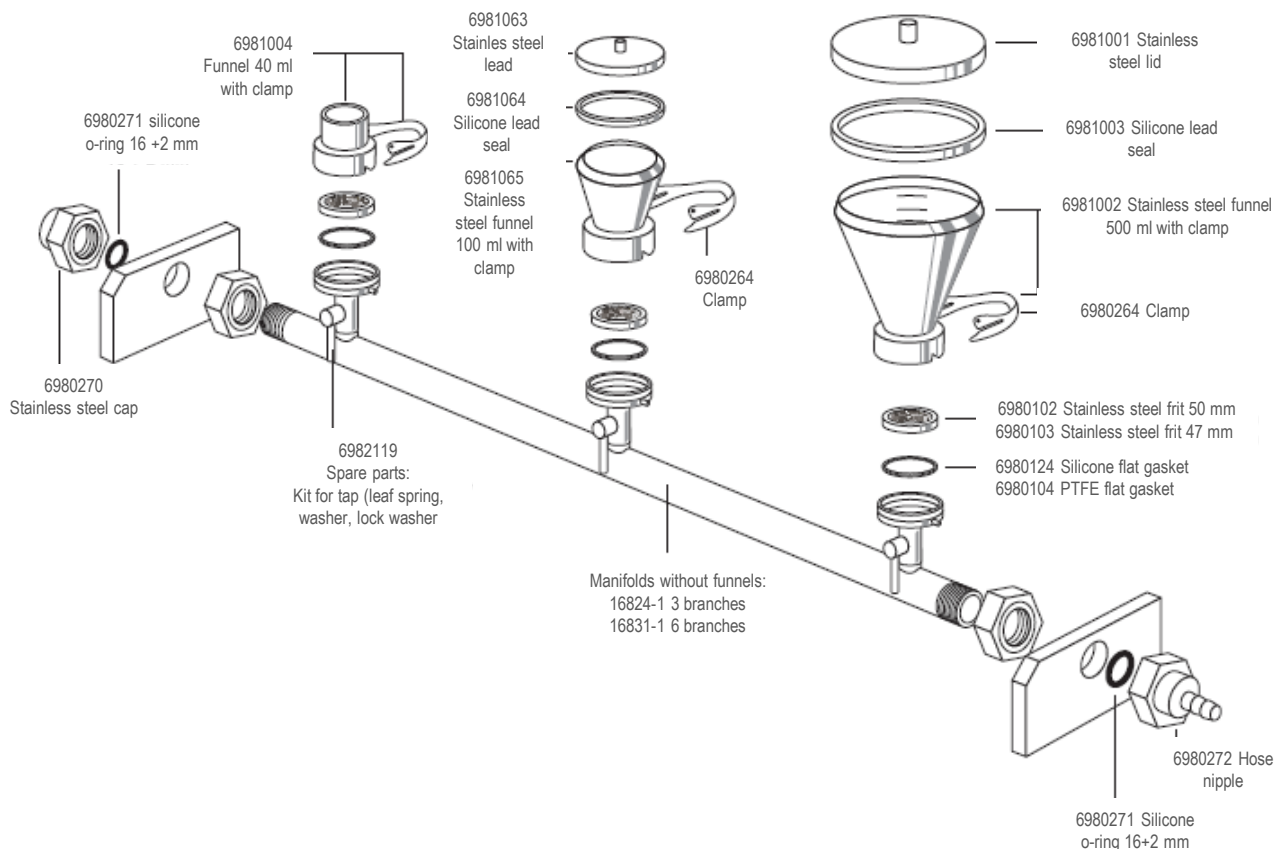

INFORMATION FOR ORDERS. Traditional stainless steel manifolds

Cod.	Description
16824	Stainless steel filtration manifold 3 branches with 100 ml funnels
16828	Stainless steel filtration manifold 3 branches with 500 ml funnels
16832	Stainless steel filtration manifold 6 branches with 100 ml funnels
16831	Stainless steel filtration manifold 6 branches with 500 ml funnels
16824-1	Stainless steel filtration manifold 3 branches without funnels
16831-1	Stainless steel filtration manifold 6 branches without funnels

INFORMATION FOR ORDERS. Accessories for traditional stainless steel manifolds

Cod.	Description
6981001	Stainless steel lid for funnel 500 ml
6981003	Silicone lid seal for funnel 500 ml
6981002	Stainless steel funnel 500 ml with clamp
6980264	Clamp
6980102	Stainless steel frite 50 mm
6980124	Silicone flat gasket
6981063	Stainless steel lid for funnel 100 ml
6981064	Silicone lid seal for funnel 100 ml
6981065	Stainless steel funnel 100 ml with clamp
6981004	Stainless steel funnel 40 ml with clamp
6980271	Silicon ring o-ring 16 x 2 mm
6980270	Stainless steel cap
6982119	Spare part kit for tap (leaf spring, washer, lock washer)
6980272	Hose nipple

Polycarbonate filtration equipment

Filtration of aqueous samples. Can be connected to Combisart® and nylon manifolds



Description

Simple filtration equipment made of polycarbonate. It has a funnel and receptor small bottle, both with 250 ml of capacity.

It can work with vacuum or light pressure (maximum 0.5 bar). In combination with a manual vacuum pump. It is an ideal equipment for the filtration of samples out of the laboratory.

In the case of sterile filtration, the filter-holder is equipped with a glass microfiber filter with 13 mm diameter, that allows the sterile ventilation for the compensation of pressure and with this form, avoid the contamination of the sterile sample. The funnel is adapted to the central aperture of the cover and avoids the spill of the liquid in the funnel.

The code 16511 is formed, only, for the upper part of the equipment (funnel and filter-holder). This is used also as a vacuum filtration funnel in filtration systems as Combisart® or in FILTER-LAB® nylon manifolds.

INFORMATION FOR ORDERS. Polycarbonate filtration equipment.

Cod.	Description
16510	Polycarbonate equipment for 47mm diameter filters. Funnel and received flask of 250 ml capacity. For vacuum or pressure filtration.
16511	Polycarbonate funnel for 47mm diameter filters of 250 ml capacity for vacuum filtration.

INFORMATION FOR ORDERS. Spare parts

Cod.	Description
16514E	Funnel with filter holder of 13 mm diameter. 12 units pack
6980110	Silicone gasket (40 x 5 mm)
6980225	Socket 10 units
6980226	Funnel
6980227	Stopper for the cap
6980228	Silicone cap. 10 unidades
6980229	Silicone gasket (80 x 3 mm). 2 units
6980230	Superior part (funnel 250 ml)
6980232	Filter basis. 2 units
6980233	Basis
6980234	Entrance hose
6980235	Silicone ring (14 x 2 mm). 3 units
6980236	Capuchón de silicona. 10 unidades
6981090	Frasco receptor 250 ml

TECHNICAL SPECIFICATIONS

Parts and materials:

Funnel with cover, lid cap, a vacuum outlet connector made of polycarbonate.

Silicone rings lid (80 x 3 mm), filter holder (40 x 5 mm) and opening system made of polypropylene.

Compounding:

Cod. 16510	Full equip
Cod. 16511	Funnel without receptor pot

Chemical compatibility:

Like polycarbonate, silicone and polypropylene

Sterilization: Autoclaving (max. 121°C). Polycarbonate resists several processes of cleaning, as long as it's cleaned after every use with vapor or with water without corrosive

Flow rate with water at 90% of emptiness: 200 ml/min with membrane filter of 0.2 µm, 700 ml/min with membrane filter of 0.45 µm

Filtration area: 12,5 cm²

Membrane filter diameter: 47 mm diameter

Capacity: Funnel and flask recipient 250 ml

Outlet nozzle: 8-10 mm diameter tube

Microbiological monitors FILTER-LAB®



Description

Microbiological monitors FILTER-LAB® are specially designed for microbiological testing for many different products: pharmaceuticals, cosmetics, beverages, food, water and other liquids.

These funnels incorporate a membrane filter and absorbent cardboard ready for use. After the filtering process, the funnel becomes a petri dish.

Microbiological monitors FILTER-LAB® are available with membrane cellulose mixed esters of 0.22, 0.45 and 0.8 microns, gridded and in white or black color tailored to the specific application.

INFORMATION FOR ORDERS. Microbiological monitors FILTER-LAB®

Código	Membrane	Diameter	Pore	Capacity	Color/grid	Format	Quantity
MB022047WGSK	MCE	47 mm	0,22 mm	100 ml	white/black	sterile, ind.	50 units/box
MB045047WGSK	MCE	47 mm	0,45 mm	100 ml	white/black	sterile, ind.	50 units/box
MB045047BGSK	MCE	47 mm	0,45 mm	100 ml	black/white	sterile, ind.	50 units/box

TECHNICAL SPECIFICATIONS

Materials

Membrane: Mixed cellulosa esters

Housing: Polystyrene

Membrane diameter: 47 mm.

Capacity funnels: 100 ml, graduated 10 ml

Pore sizes: 0.22, 0.45 y 0.8 μ m

Surface colors: white, black

Filtration area: 14,5 cm²

Outlet: 6.5 x 1.5 mm

Lot number: Yes

Advantages

- Easy to use, ready for use
- Avoid the risk of contamination to be sterilized in individual blister.
- Different color range and pore sizes
- Economic since become a petri dish with the absorbent pad included.
- Possibility of connecting in most popular filtration devices.
- A single use avoid work cleaning and sterilization

Applications

- Microbiological analyses of pharmaceutical products, beverages, cosmetics, foods, mineral waters, etc.

Combisart® Single filtration equipment



Description

Individual manifold vacuum filtration specially designed to incorporate a single use funnels and Microsart® funnels 47 mm diameter for microbiological analysis. It is made of stainless steel AISI 304/304S31 approved and silicone (gasket).

A shutoff valve to open or close the gap as needed by the analyst.

Can be sterilized by autoclaving, dry heat or flamed using another method according to ISO 8199.

INFORMATION FOR ORDERS. Combisart single manifold

Cod.	Description
16844	Combisart single manifold
17575ACK	Sterile venting filters PTFE 0.2 µm. 50 units pack
1ZU-0001	Frite for base connection Microsart
16840	Base with stainless steel frite

TECHNICAL SPECIFICATIONS

Stainless steel quality

B.S. 304S31 | AISI 304

Dimensions in mm (length x height x width)

Maximum pressure: Only vacuum

Sterilization

Autoclaving (maximum 134°C), dry heat (maximum 180°C), flamed, other methods according to ISO 8199

Parts and materials

Stainless steel.
Gaskets made of silicone.

Flow rate per each funnel with water and empty at 90%

200 ml/min with 0.2 µm membrane
600 ml/min with 0.45 µm membrane

Filtration area

12.5 cm²

Filters diameter

50 mm, 47 mm (using frite basis cod. 6980103)

Output vacuum connector

10 mm. diameter tube

Glass filtration equipment



Description

Equipo de filtración de vidrio monopuesto por vacío. Este equipo esta formado por las siguientes partes:

- 250 ml funnel capacity, graduated
- Glass porous plate grade 3
- 1000 ml received flask capacity
- Aluminium clamp

TECHNICAL SPECIFICATIONS

Materials

Glass 100% borosilicate except aluminium clamp

Capacities

Funnel	300 ml
Received flask	1000 ml

Porosity plate

Grade 3

Esterilization

Autoclaving (134°C maximum), dry heat (180°C maximum).

Filter size

47 mm diameter

Vacuum connection to outlet

8 - 10 mm. Diameter tube

INFORMATION FOR ORDERS. Glass vacuum filtration equipment

Cod.	Description
G047/M	Full equipment
E047/1	300 ml funnel, graduated
E047/4	Aluminium clamp
G047/5	Porous plate
E047/7	1000 ml received flask

Filtration accessories



Tweezers for membranes cod. 16625

Manufactured in stainless steel. Can be flame treated or sterilized. They have the tip specially adapted to avoid damages to the membranes.

Applications

- Membrane transport to avoid contamination



Absorbent cartons microbiology

Manufactured with 100% virgin cellulose for the absorption of the culture media in microbiological analysis. Presentation in packs of 1000 units separated by cylinders of 100 units. Includes dispenser. Manufactured in 47 and 50 mm diameter.

Applications

- Absorption of the culture media in microbiological analysis.

Cod.	Description
15410-047ALR	Absorbent pads 47 mm diameter. Box 1000 units.
15410-050ALR	Absorbent pads 50 mm diameter. Box 1000 units.



Special tube for vacuum cod. TG-10

Special rubber tube for vacuum thanks to the huge thickness of the wall. Internal diameter of 7 mm, very appropriate for connections between manifolds, filtration systems, filter-holders and other dispositive with vacuum pump between them. Length: 1.5 m

Applications

- Connection between filtering systems and vacuum source.



Suction flasks

Glass flasks of 2 and 5 liters of capacity used as a trap for the liquid coming from suction and as a basis of support for funnels in combination with silicone cap with an orifice. It has a connection for vacuum with nut.

Applications

- Vacuum bottle and basis of support for vacuum filtration funnels.

Cod.	Description
16672	Suction flask of 2 l, stopper
16672-1	Suction flask of 5 l, includes stopper
17173	Silicone cap for stainless steel funnel (16201, 16219, 16220)
17174	Silicone cap for glass funnel 16306 (25 mm diameter)
17175	Silicone cap for glass funnel 16307 (47 mm diameter)



Vacuum bottle cod. 16610

Glass bottle specially manufactured as a trap for the liquid of suction in vacuum filtration systems. It has revolving input and output, backflow valve to regulate vacuum. Capacity: 500 ml

Applications

- Trap for liquids in vacuum filtration systems.

Filtration accessories



Vacuum pump protector cod. 17804-A

Venting filter with PTFE membrane of 0.45 μm .
Input and output entrance for tube 8-10 mm

Applications

- Vacuum pump protections against liquids.



Stainless steel prefilter cod. 16807

This stainless steel dispositive allows the elimination of thick particles of the samples for microbiological analysis.

It's placed between the funnel and the frit of the equipment. It can be flame treated and sterilized. For pre-filtration, it uses a cellulose nitrate membrane of 8 μm pore, which allows microorganisms, but holds back thick particles. These bacteria will stay afterwards held back in the final membrane of 0.45 μm .

After the filtering process, it's incubated and the colonies can grow up without the perturbation caused by an excess of particles in the filter surface.

Applications

- Pre-filtration of samples with a high charge of particles in microbiologic analysis.

Cod.	Description
16807	Stainless steel prefilter
6981139	Base plate

WaterVac 100 Filtration System

Stainless steel funnels, polypropylene or magnetics connected to a direct transfer vacuum pump



Description

WaterVac 100 is a multi-filtration system that allows several possible configurations according to the requirements of each laboratory, always on the basis of a direct transfer vacuum pump easy handling and without maintenance.

Can be connected stainless steel funnels, single use, magnetic funnels, monitors and microbiological monitors and polyethersulfone funnels with threaded base.

As a universal adapter can use a silicone stopper with hole, but we also have specific adapters for stainless steel funnels or for single use.

Advantages

- No need bottle suction pump saver or any accessory by traditional method.
- No need to empty the suction flask.
- Can not be produced accidents with the liquid inlet in the vacuum pump.
- Very versatile thanks to its various configurations:
 - Stainless steel funnels fried the same material
 - Polypropylene funnels single use
 - Funnels with magnetic base polycarbonate
 - Microbiological Monitors
- Space saving

Technical specifications for the vacuum pump WaterVac WV-100

- Max. vacuum:** 540 mm Hg
- Max. air flow rate:** 2.2 l/m
- Max. water flow rate:** 0.5 l/m
- Weight:** 1.16 kg
- Power:** DC 12 V, 1.5 A
- Range of temperature:** 5 – 40°C
- Dimensions:** 170 x 120 x 96 mm (L x W x H)
- Parts and materials:**
 - Housing: stainless steel with paint powder.
 - Valve plate - EPDM (ethylene propylene diene monomer).
 - Diafragma: EPDM (ethylene propylene diene monomer).
 - Fluid path input / output port: stainless steel # 316
 - O-ring: FKM
 - Fluid path hose: Silicone tube
 - Drain hose: silicon, Ø4 mm / Ø8 mm, 2 meters

Applications

- Microbiological analysis
- Determination of suspended solids in water samples
- General filtration of aqueous samples where is not necessary to collect the filtrate



WaterVac 100 Filtration System Magnetic funnels



Advantages

- Easy assembly of the magnetic funnel
- Compatible with a large range of solvents
- High temperature resistant
- Robust construction
- Reusable
- Prepared to filter continuously
- Graduated

INFORMATION FOR ORDERS

Cod.	Description
WV100-8	WaterVac 100 filtration system with adapter for silicone stopper with hole
MG300	Magnetic filtration equipment 300 ml
MG500	Magnetic filtration equipment 500 ml
JPT022025T	PTFE syringe filters 0.22 µm, 25 mm Bag 10 units
LMG	Polypropylene lid
FMG300	300 ml magnetic funnel with lid
FMG500	500 ml magnetic funnel with lid
FTMG47	Polypropylene frite 47 mm diameter
SMG47	Magnetic support base with polypropylene frite
STP8	Silicone stopper with hole n° 8

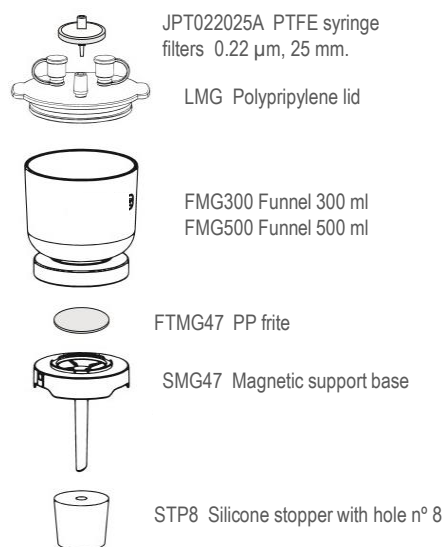

JPT022025A PTFE syringe filters 0.22 µm, 25 mm.

LMG Polypropylene lid

FMG300 Funnel 300 ml
FMG500 Funnel 500 ml

FTMG47 PP frite

SMG47 Magnetic support base

STP8 Silicone stopper with hole n° 8

WaterVac 100 Filtration System Polyethersulphone (PES) funnels



Advantages

- Compatible with a high range of solvents
- High temperature resistant
- Robust estructure
- Reusable
- Prepared for filter continuously
- Very versatile. It can be connected to different types of equipment.
- Graduated funnels

INFORMATION FOR ORDERS

Code	Description
WV100-8	WaterVac 100 filtration system with adapter for silicone stopper with hole
PES300	PES filtration equipment 300 ml
PES500	PES filtration equipment 500 ml
JPT022025T	PTFE syringe filters 0.22 µm, 25 mm. Bag 10 units
LPES	PES lid for funnels 300 and 500 ml
FPS300	PES funnel 300 ml. Stopper included
FPS500	PES funnel 500 ml. Stopper included
FTPES47	PP frite 47 mm diameter
SPS47	Support base
STP8	Silicone stopper with hole nº 8

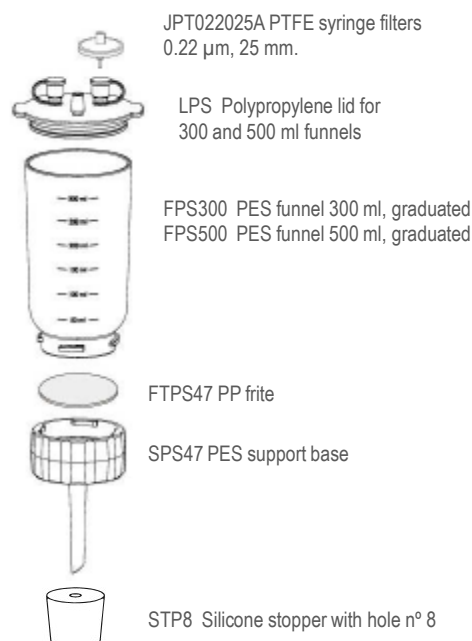

JPT022025A PTFE syringe filters
0.22 µm, 25 mm.

LPS Polypropylene lid for
300 and 500 ml funnels

FPS300 PES funnel 300 ml, graduated
FPS500 PES funnel 500 ml, graduated

FTPS47 PP frite

SPS47 PES support base

STP8 Silicone stopper with hole nº 8

WaterVac 100 Filtration System Stainless steel funnels



Advantages

- Compatible with most solvents
- High temperature resistant
- Robust structure
- Reusable
- Very versatile. It can be connected to different types of equipment.
- It can be connected via a plug and a special support

INFORMATION FOR ORDERS

Cod.	Description
WV100-8	WaterVac 100 filtration system with adapter for silicone stopper with hole
WV100	WaterVac filtration system without adapter
CSS47	Adapter for stainless steel funnels to WaterVac WV100
SS100	Full filtration equipment 100 ml, stopper included
SS500	Full filtration equipment 500 ml, stopper included
FSS500	Stainless steel funnel 500 ml
FSS100	Stainless steel funnel 100 ml
LSS500	Stainless steel lid for 500 ml funnel
LSS100	Stainless steel lid for 100 ml funnel
FTSS47	Stainless steel frit 47 mm diameter
SSSP47	Stainless steel support base
STP8	Silicone stopper with hole n° 8

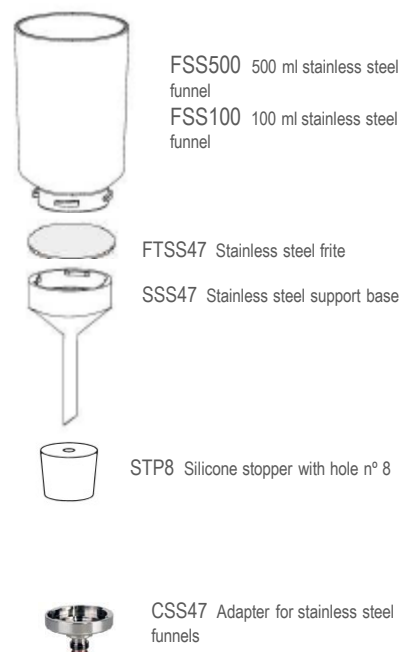

WaterVac 100 Filtration System Single use funnels



Advantages

- o Compatible with Sartorius, Millipore and Pall single use funnels.



CP47WW Adapter for Pall single use funnels



CM47WW Adapter for Millipore single use funnels



CS47WW Adapter for Sartorius single use funnels

INFORMATION FOR ORDERS

Cod.	Description
WV100	WaterVac 100 filtration system without adapter
CM47WW	Adapter for Millipore funnels
CS47WW	Adapter for Sartorius funnels
CP47WW	Adapter for Pall funnels

WaterVac 100 Filtration System Microbiological Monitors



Advantages

- Compatible with different biological monitors
- Easy to use

INFORMATION FOR ORDERS

Cod.	Description
WV100-8	WaterVac 100 filtration system with silicone stopper adapter
MB022047WGSK	Microbiological monitors 0.22 μm , 47 mm, white, gridded, sterile. Pack 50 units
MB045047WGSK	Microbiological monitors 0.45 μm , 47 mm, white, gridded, sterile. Pack 50 units
MB045047BGSK	Microbiological monitors 0.45 μm , 47 mm, black, gridded, sterile. Pack 50 units

WaterVac 100 Filtration System Accessories



Polyethersulphone (PES) bottle code VB-3000

Capacity: 3 liters
 Input and output connection: tube 6-10 mm diameter
 Lid closure by pressure
 Patent security system protect the vacuum pump without use venting filter
 Graduated every 200 ml



Polyethersulfone (PES) bottle code VB-1200

Capacity: 1.2 liters
 Vacuum output: tube 6-10 mm diameter
 Screw lid. Threaded plug
 Patent security system protect the vacuum pump without use venting filter
 Graduated every 100 ml.
 It can be connect by threaded PES funnels. Magnetic and stainless steel funnels and microbiological monitors by silicone stopper.



Adapter for WaterVac 100 to rubber tube code CTWV

Material: Stainless steel
 Tube diameter: 4-8 mm



Adapter for connect silicone stopper code CAWV

Material: Stainless steel



Special rubber tube for vacuum equipments code TG-10

Length: 1,5 meters
 Diameter: 8 mm



Silicone stopper as adapters

2 sizes

INFORMATION FOR ORDERS

Cod.	Description
VB-3000	Polyethersulphone (PES) bottle with security system. Capacity: 3 liters
VB-1200	Polyethersulphone (PES) bottle with security system. Capacity 1.2 liters
CTWV	Adapter for connect rubber tube 4 - 8 mm diameter to WaterVac 100
CAWV	Adapter for connect a silicone stopper to WaterVac 100
TG-10	Special rubber tube for vacuum 1,5 meters, 8 mm diameter
STP8	Silicone stopper with hole nº 8
STP16	Silicone stopper with hole nº 16

Code	Page	Code	Page	Code	Page	Code	Page
16214	139	16645E	132	BP1200056	68	CC33100	46, 47
16219	149	16646E	132	BP1200072	68	CC33118	46, 47
16220	149	16647E	132	BP1200093	68	CC3380	46, 47
16251	140	16672	156	BV-1000	147	CC3394	46, 47
16254	141	16672-1	156	BV-300	146	CC35100	46, 47
16574	137	16685-2	142	BV-411-CR	147	CC35110	46, 47
16639	132	166MP-4	147	BV-500	146	CC35150	46, 47
16712	92, 93	16807	157	CAWV	162	CC3550	46, 47
16824	150, 151	16824-1	150, 151	CB1050	50	CC3560	46, 47
16828	150, 151	16831-1	150, 151	CB1990	50	CC3580	46, 47
16831	150, 151	16840	154	CB2280	50	CC40100	46, 47
16832	150, 151	16844	154	CB2660	50	CC40123	46, 47
6980102	149, 150, 151	17173	156	CB2680	50	CC48145	46, 47
6980103	149, 150, 151	17174	156	CB30100	50	CC50160	46, 47
6980104	149, 150, 151	17175	156	CB3080	50	CC53145	46, 47
6980110	142	17575-ACK	156	CB3380	50	CC60120	46, 47
6980124	149, 150, 151	17804 A	143	CB3394	50	CC68250	46, 47
6980236	152	17804 E	143	CB35150	50	CC75160	46, 47
6980264	149, 150, 151	17804 G	143	CB43123	50	CC90180	46, 47
6980270	150, 151	17804 NPE	143	CB53145	50	CC90210	46, 47
6980271	150, 151	17804 NPG	143	CC1050	46, 47	CCDG1990	46, 47
6980272	150, 151	17805 E	143	CC1050	46, 47	CCDG2280	46, 47
6980383	142	17805 G	143	CC16100	46, 47	CCDG25100	46, 47
6980569	136	17805 NPE	143	CC16100	46, 47	CCDG28100	46, 47
6980595	139	17805 NPG	143	CC1990	46, 47	CCDG30100	46, 47
6980721	141	17805 UPN	143	CC1990	46, 47	CCDG33100	46, 47
6980737	141	1EDS-D0055	138	CC22100	46, 47	CCDG3380	46, 47
6981001	149, 150, 151	1ZE-0028	92, 93	CC22100	46, 47	CCDG3394	46, 47
6981002	149, 150, 151	1ZU-0001	154	CC2250	46, 47	CCDG35100	46, 47
6981003	149, 150, 151	6980101	149, 150, 151	CC2250	46, 47	CCDG60120	46, 47
6981004	149, 150, 151	6980176	140	CC2260	46, 47	CCDG68250	46, 47
6981031	140	6980178	141	CC2260	46, 47	CCDG75160	46, 47
6981032	140	6980180	141	CC2280	46, 47	CCDG90180	46, 47
6981034	140	6980225	152	CC2280	46, 47	CM47WW	162
6981063	149, 150, 151	6980226	152	CC24110	46, 47	CP1482100150	71
6981064	150, 151	6980227	152	CC24110	46, 47	CP47WW	162
6981065	150, 151	6980228	152	CC25100	46, 47	CQ20001990	51
6981090	152	6980229	152	CC25100	46, 47	CQ20002265	51
6982003	141	6980230	152	CC2565	46, 47	CQ20002270	51
6982005	141	6980232	142, 152	CC2565	46, 47	CQ200025100	51
6982006	141	6980233	152	CC2570	46, 47	CQ20002570	51
6982119	149, 150, 151	6980234	152	CC2570	46, 47	CQ20002660	51
6985004	142	6980235	152	CC2580	46, 47	CQ200030100	51
01324	132	6980656	141	CC2580	46, 47	CQ200030110	51
01325	132	6980717	141	CC2660	46, 47	CQ20003077	51
15410-47ALR	156	6980722	141	CC2660	46, 47	CQ20003080	51
15410-50ALR	156	6980801	141	CC27100	46, 47	CQ200034150	51
16201	149	6981064	149, 150, 151	CC27100	46, 47	CQ200035150	51
16508B	142	6981065	149, 150, 151	CC2780	46, 47	CQ200043123	51
16508B-1	142	6981139	157	CC2780	46, 47	CS47WW	162
16510	152	6986070	132	CC28100	46, 47	CSS47	161
16511	152	6986071	132	CC28100	46, 47	CT14312575	71
16514E	136	6986072	132	CC2880	46, 47	CT14324526	71
16514E-2	136	6986073	132	CC2880	46, 47	CT14334526	71
16517E	138	911S	66	CC30100	46, 47	CTWV	161
16517E-2	138	920S	66	CC30100	46, 47	DP50	31
16596 HYK	143	BB150550100	33	CC3060	46, 47	DP70	31
16596 HYQ	143	BB15055050	33	CC3060	46, 47	E047/1	155
16610	156	BB150850100	33	CC3077	46, 47	E047/4	155
16625	156	BB15085050	33	CC3077	46, 47	E047/7	155
16644E	132	BBSC240500	31	CC3080	46, 47	FM100047	45, 46

Code	Page	Code	Page	Code	Page	Code	Page
FM100055	45, 46	FM36150	45, 46	HJ1235460570	16	HJBLT2130100	54
FM100070	45, 46	FM36200	45, 46	HJ1238203254	16	HJBLT2150200	54
FM100090	45, 46	FM500047	45, 46	HJ1238460570	16	HJBLT2200200	54
FM100110	45, 46	FM500055	45, 46	HJ1240203254	16	HJBLT221090	54
FM100125	45, 46	FM500070	45, 46	HJ1240460570	16	HJBLT2460570	54
FM100150	45, 46	FM500090	45, 46	HJ1242203254	16	HJBLT2580600	54
FM100200	45, 46	FM500110	45, 46	HJ1242460570	16	HJBLT29380	54
FM10047	45, 46	FM500125	45, 46	HJ1244203254	16	HJBLT310070	54
FM10055	45, 46	FM500150	45, 46	HJ1244460570	16	HJBLT3130100	54
FM10070	45, 46	FM500200	45, 46	HJ1246203254	16	HJBLT3150200	54
FM10090	45, 46	FM50047	45, 46	HJ1246460570	16	HJBLT3200200	54
FM10110	45, 46	FM50055	45, 46	HJ1248460570	26	HJBLT321090	54
FM10125	45, 46	FM50070	45, 46	HJ1249460570	26	HJPC5100150	52
FM10150	45, 46	FM50090	45, 46	HJ1250460570	26	HJPC5120140	52
FM10200	45, 46	FM50110	45, 46	HJ1252460570	26	HJPC5150200	52
FM150047	45, 46	FM50125	45, 46	HJ1254460570	26	HJPC5200200	52
FM150055	45, 46	FM50150	45, 46	HJ1256460570	26	HJPC5460570	52
FM150070	45, 46	FM50200	45, 46	HJ1300460570	22	HJPC5580600	52
FM150090	45, 46	FM710047	45, 46	HJ1300G460570	22	HJPF102020	78
FM150110	45, 46	FM710055	45, 46	HJ1303460570	22	HJPF104040	78
FM150125	45, 46	FM710070	45, 46	HJ1318460570	22	HJPF106060	78
FM150150	45, 46	FM710090	45, 46	HJ1320460570	22	HJPF302020	78
FM150200	45, 46	FM710110	45, 46	HJ1326460570	22	HJPF304040	78
FM200047	45, 46	FM710125	45, 46	HJ14433546	70	HJPF306060	78
FM200055	45, 46	FM710150	45, 46	HJ15053242	33	HJPF352020	78
FM200070	45, 46	FM710200	45, 46	HJ15054252	33	HJPF354040	78
FM200090	45, 46	FM75047	45, 46	HJ15054657	33	HJPF356060	78
FM200110	45, 46	FM75055	45, 46	HJ15055050	33	HJPF3952020	78
FM200125	45, 46	FM75070	45, 46	HJ15083242	33	HJPF3954040	78
FM200150	45, 46	FM75090	45, 46	HJ15084252	33	HJPF3956060	78
FM200200	45, 46	FM75110	45, 46	HJ15084657	33	HJPF502020	78
FM20047	45, 46	FM75125	45, 46	HJ15085050	33	HJPF504040	78
FM20055	45, 46	FM75150	45, 46	HJ1860100100	55	HJPF506060	78
FM20070	45, 46	FM75200	45, 46	HJ1860130130	55	HJPF5952020	78
FM20090	45, 46	FM900047	45, 46	HJ1860150150	55	HJPF5954040	78
FM20110	45, 46	FM900055	45, 46	HJ1860170170	55	HJPF5956060	78
FM20125	45, 46	FM900070	45, 46	HJ1860180180	55	HJPF7952020	78
FM20150	45, 46	FM900090	45, 46	HJ1860200200	55	HJPF7954040	78
FM20200	45, 46	FM900110	45, 46	HJ1860210297	55	HJPF7956060	78
FM250047	45, 46	FM900125	45, 46	HJ1860220220	55	HJS1904252	58
FM250055	45, 46	FM900150	45, 46	HJ1860230230	55	HJS1905858	58
FM250070	45, 46	FM900200	45, 46	HJ1860250230	55	HJS3001010	58
FM250090	45, 46	FMG300	159	HJ1860250250	55	HJS3001015	58
FM250110	45, 46	FMG500	159	HJ1860420520	55	HJS3002020	58
FM250125	45, 46	FPS300	160	HJ1860480480	55	HJS3003242	58
FM250150	45, 46	FPS500	160	HJ2235203254	20	HJS3004252	58
FM250200	45, 46	FSS100	161	HJ2235460570	20	HJS3005858	58
FM25047	45, 46	FSS500	161	HJ2240203254	20	HJS4001010	58
FM25055	45, 46	FTMG47	159	HJ2240460570	20	HJS4001015	58
FM25070	45, 46	FTPES47	160	HJ2244203254	20	HJS4002020	58
FM25090	45, 46	FTSS47	161	HJ2244460570	20	HJS4003242	58
FM25110	45, 46	G047/5	155	HJ989W/7840	66	HJS4004252	58
FM25125	45, 46	G047/M	155	HJBLT110070	54	HJS4005858	58
FM25150	45, 46	HJ1200100100	68	HJBLT1130100	54	HJS4501010	58
FM25200	45, 46	HJ1200150150	68	HJBLT1150200	54	HJS4501015	58
FM36047	45, 46	HJ1200200200	68	HJBLT1200200	54	HJS4502020	58
FM36055	45, 46	HJ12005050	68	HJBLT121090	54	HJS4503242	58
FM36070	45, 46	HJ12007575	68	HJBLT1460570	54	HJS4504252	58
FM36090	45, 46	HJ1232203254	16	HJBLT1580600	54	HJS4505858	58
FM36110	45, 46	HJ1232460570	16	HJBLT19380	54	HJS5001010	58
FM36125	45, 46	HJ1235203254	16	HJBLT210070	54	HJS5001015	58

Code	Page	Code	Page	Code	Page	Code	Page
HJS5002020	58	JNY022025R	120	MB022047BGSK	153	MCE065047N	86
HJS5003242	58	JNY022033N	120	MB022047WGSK	153	MCE065047WGSN	86
HJS5004252	58	JNY022033R	120	MB045047BGSK	153	MCE065090N	86
HJS5005858	58	JNY045013N	120	MB045047WGSK	153	MCE065142K	86
HJS6001010	58	JNY045013R	120	MB080047BGSK	153	MCE065293K	86
HJS6001015	58	JNY045025N	120	MB080047WGSK	153	MCE080047BGN	86
HJS6002020	58	JNY045025R	120	MCA022013N	84	MCE080047BGSN	86
HJS6003242	58	JNY045033N	120	MCA022025N	84	MCE080047WGN	86
HJS6004252	58	JNY045033R	120	MCA022047N	84	MCE080047WGSN	86
HJS6005858	58	JNES022013N	118	MCA022090N	84	MCE100013N	86
HJS7201010	58	JNES022013R	118	MCA022142K	84	MCE100025N	86
HJS7201015	58	JNES022025N	118	MCA022293K	84	MCE100037N	86
HJS7202020	58	JNES022025R	118	MCA045013N	84	MCE100047N	86
HJS7203242	58	JNES045013N	118	MCA045025N	84	MCE100090N	86
HJS7204252	58	JNES045013R	118	MCA045047N	84	MCE100142K	86
HJS7205858	58	JNES045025N	118	MCA045090N	84	MCE100293K	86
JCA022013N	112	JNES045025R	118	MCA045142K	84	MCE120047BGSN	86
JCA022013R	112	JPT022025T	158	MCA045293K	84	MCE120047WGSN	86
JCA022025N	112	JPT022025T	157	MCA080013N	84	MCE300013N	86
JCA022025R	112	JPV022013N	122	MCA080025N	84	MCE300025N	86
JCA022033N	112	JPV022013R	120	MCA080047N	84	MCE300047N	86
JCA022033R	112	JPV022025N	120	MCA080090N	84	MCE300090N	86
JCA045013N	112	JPV022025R	120	MCA080142K	84	MCE300142K	86
JCA045013R	112	JPV045013N	120	MCA080293K	84	MCE300293K	86
JCA045025N	112	JPV045013R	120	MCA300013N	84	MCE500013N	86
JCA045025R	112	JPV045025N	120	MCA300025N	84	MCE500025N	86
JCA045033N	112	JPV045025R	120	MCA300047N	84	MCE500047N	86
JCA045033R	112	JPVH022013N	120	MCA300090N	84	MCE500090N	86
JCA080013N	112	JPVH022013R	120	MCA300142K	84	MCE500142K	86
JCA080013R	112	JPVH022025N	120	MCA300293K	84	MCE500293K	86
JCA080025N	112	JPVH022025R	120	MCA500013N	84	MCE800013N	86
JCA080025R	112	JPVH022033N	120	MCA500025N	84	MCE800025N	86
JCA120013N	112	JPVH022033R	120	MCA500047N	84	MCE800047N	86
JCA120013R	112	JPVH045013N	120	MCA500090N	84	MCE800090N	86
JCA120025N	112	JPVH045013R	120	MCA500142K	84	MCE800142K	86
JCA120025R	112	JPVH045025N	120	MCA500293K	84	MCE800293K	86
JCA500013N	112	JPVH045025R	120	MCE022013N	86	MFQ025	37
JCA500013R	112	JPVH045033N	120	MCE022025N	86	MFQ037	37
JCA500025N	112	JPVH045033R	120	MCE022037N	86	MFQ047	37
JCA500025R	112	JPVS022013K	120	MCE022047BGN	86	MFQ055	37
JCAS022013K	112	JPVS022025K	120	MCE022047BGSN	86	MFQ070	37
JCAS022025K	112	JPVS045013K	120	MCE022047N	86	MFQ090	37
JCAS022033K	112	JPVS045025K	120	MCE022047WGN	86	MFQ110	37
JCAS045013K	112	LMG	157	MCE022047WGSN	86	MFQ125	37
JCAS045025K	112	LPES	158	MCE022090N	86	MFQ150	37
JCAS045033K	112	LSS100	159	MCE022142K	86	MFQ203254	37
JCAS080013K	112	LSS500	159	MCE022293K	86	MFQ360025	37
JCAS080025K	112	M30002020-12	81	MCE045013N	86	MFQ360037	37
JCAS120013K	112	M30002020-18	81	MCE045025N	86	MFQ360047	37
JCAS120025K	112	M30002020-36	81	MCE045037N	86	MFQ360055	37
JCAS500013K	112	M30002020-6	81	MCE045047BGN	86	MFQ360070	37
JCAS500025K	112	M3000-AG	81	MCE045047BGSN	86	MFQ360090	37
JGF070025N	116	M3000-BG	81	MCE045047N	86	MFQ360110	37
JGF070025R	116	M3000INOX2020-12	81	MCE045047WGN	86	MFQ360125	37
JGFCA022025N	114	M3000INOX2020-18	81	MCE045047WGSN	86	MFQ360150	37
JGFCA022025R	114	M3000INOX2020-36	81	MCE045090N	86	MFQ360203254	37
JGFCA045025N	114	M3000INOX2020-6	81	MCE045142K	86	MFV1013	34
JGFCA045025R	114	M3000-PB	81	MCE045293K	86	MFV1025	34
JNY022013N	120	M3000-PRE	81	MCE065013N	86	MFV1037	34
JNY022013R	120	M3000-PRS	81	MCE065025N	86	MFV1047	34
JNY022025N	120	M3000-V1	81	MCE065047BGSN	86	MFV1055	34

Code	Page	Code	Page	Code	Page	Code	Page
MFV1070	34	MFV6460570	34	MPC1200047N	104	NY200070	46
MFV1080	34	MFVL7025	36	MPC1400013N	104	NY200090	46
MFV1090	34	MFVL7037	36	MPC1400025N	104	NY200110	46
MFV1110	34	MFVL7047	36	MPC1400047N	104	NY200125	46
MFV1125	34	MFVL7055	36	MPC2000013N	104	NY200150	46
MFV1150	34	MFVL7070	36	MPC2000025N	104	NY200200	46
MFV1203254	34	MFVL7090	36	MPC2000047N	104	NY20047	46
MFV2013	34	MFVL7110	36	MPES010025N	96	NY20055	46
MFV2025	34	MFVL7125	36	MPES010047N	96	NY20070	46
MFV2037	34	MFVL7150	36	MPES022025N	96	NY20090	46
MFV2047	34	MFVL8025	36	MPES022047N	96	NY20110	46
MFV2055	34	MFVL8037	36	MPES045025N	96	NY20125	46
MFV2070	34	MFVL8047	36	MPES045047N	96	NY20150	46
MFV2090	34	MFVL8055	36	MPP022025N	100	NY20200	46
MFV2110	34	MFVL8070	36	MPP022047N	100	NY250047	46
MFV2125	34	MFVL8090	36	MPP045025N	100	NY250055	46
MFV2150	34	MFVL8110	36	MPP045047N	100	NY250070	46
MFV2460570	34	MFVL8125	36	MPT022013N	98	NY250090	46
MFV3013	34	MFVL8150	36	MPT022025N	98	NY250110	46
MFV3025	34	MG300	159	MPT022047N	98	NY250125	46
MFV3037	34	MG500	159	MPT022090N	98	NY250150	46
MFV3047	34	MNY022013N	94	MPT022142G	98	NY250200	46
MFV3055	34	MNY022025N	94	MPT022142G	98	NY25047	46
MFV3070	34	MNY022047N	94	MPT045013N	98	NY25055	46
MFV3090	34	MNY022090N	94	MPT045025N	98	NY25070	46
MFV3110	34	MNY022142K	94	MPT045047N	98	NY25090	46
MFV3125	34	MNY022293K	94	MPT045090N	98	NY25110	46
MFV3150	34	MNY045013N	94	MPT045142G	98	NY25125	46
MFV3460570	34	MNY045025N	94	MPT045142G	98	NY25150	46
MFV4013	34	MNY045047N	94	MPT120013N	98	NY25200	46
MFV4025	34	MNY045090N	94	MPT120025N	98	NY35047	46
MFV4037	34	MNY045142K	94	MPT120047N	98	NY35055	46
MFV4047	34	MNY045293K	94	MPT120142G	98	NY35070	46
MFV4055	34	MNY500047N	94	MPT120142G	98	NY35090	46
MFV4070	34	MPC0010013N	104	MPT500013N	98	NY35110	46
MFV4090	34	MPC0010025N	104	MPT500025N	98	NY35125	46
MFV4110	34	MPC0010047N	104	MPT500047N	98	NY35150	46
MFV4125	34	MPC0020013N	104	MPT500142G	98	NY35200	46
MFV4150	34	MPC0020025N	104	MPT500142G	98	NY500047	46
MFV4460570	34	MPC0020047N	104	MPV022025N	102	NY500055	46
MFV5013	34	MPC0040013N	104	MPV022047N	102	NY500070	46
MFV5025	34	MPC0040025N	104	MPV045025N	102	NY500090	46
MFV5037	34	MPC0040047N	104	MPV045047N	102	NY500110	46
MFV5047	34	MPC0040047SN	104	NY100047	46	NY500125	46
MFV5055	34	MPC0080013N	104	NY100055	46	NY500150	46
MFV5070	34	MPC0080025N	104	NY100070	46	NY500200	46
MFV5090	34	MPC0080047N	104	NY100090	46	NY50047	46
MFV5110	34	MPC0200013N	104	NY100110	46	NY50055	46
MFV5125	34	MPC0200025N	104	NY100125	46	NY50070	46
MFV5150	34	MPC0200047N	104	NY100150	46	NY50090	46
MFV5460570	34	MPC0300013N	104	NY100200	46	NY50110	46
MFV6013	34	MPC0300025N	104	NY150047	46	NY50125	46
MFV6025	34	MPC0300047N	104	NY150055	46	NY50150	46
MFV6037	34	MPC0500013N	104	NY150070	46	NY50200	46
MFV6047	34	MPC0500025N	104	NY150090	46	NY750047	46
MFV6055	34	MPC0500047N	104	NY150110	46	NY750055	46
MFV6070	34	MPC0800013N	104	NY150125	46	NY750070	46
MFV6090	34	MPC0800025N	104	NY150150	46	NY750090	46
MFV6110	34	MPC0800047N	104	NY150200	46	NY750110	46
MFV6125	34	MPC1200013N	104	NY200047	46	NY750125	46
MFV6150	34	MPC1200025N	104	NY200055	46	NY750150	46

Code	Page	Code	Page	Code	Page	Code	Page
NY750200	46	PL1244200	16	PL1252270	26	PL1300150	22
NY900047	46	PL1244240	16	PL1252300	26	PL1300185	22
NY900055	46	PL1244250	16	PL1252320	26	PL1300200	22
NY900070	46	PL1244270	16	PL1254070	26	PL1300240	22
NY900090	46	PL1244320	16	PL1254090	26	PL1300250	22
NY900110	46	PL1246070	16	PL1254110	26	PL1300270	22
NY900125	46	PL1246090	16	PL1254125	26	PL1300300	22
NY900150	46	PL1246110	16	PL1254150	26	PL1300320	22
NY900200	46	PL1246125	16	PL1254185	26	PL1300350	22
PES300	160	PL1246150	16	PL1254200	26	PL1300400	22
PES500	160	PL1246185	16	PL1254240	26	PL1300450	22
PL1235070	16	PL1246200	16	PL1254250	26	PL1300500	22
PL1235090	16	PL1246240	16	PL1254270	26	PL1300650	22
PL1235110	16	PL1246250	16	PL1254300	26	PL1300800	22
PL1235125	16	PL1246270	16	PL1254320	26	PL1300G070	22
PL1235150	16	PL1246320	16	PL1256070	26	PL1300G090	22
PL1235185	16	PL1248070	26	PL1256090	26	PL1300G1000	22
PL1235200	16	PL1248090	26	PL1256110	26	PL1300G110	22
PL1235240	16	PL1248110	26	PL1256125	26	PL1300G125	22
PL1235250	16	PL1248125	26	PL1256150	26	PL1300G130	22
PL1235270	16	PL1248150	26	PL1256185	26	PL1300G150	22
PL1235320	16	PL1248185	26	PL1256200	26	PL1300G185	22
PL1238070	16	PL1248200	26	PL1256240	26	PL1300G200	22
PL1238090	16	PL1248240	26	PL1256250	26	PL1300G240	22
PL1238110	16	PL1248250	26	PL1256270	26	PL1300G250	22
PL1238125	16	PL1248270	26	PL1256300	26	PL1300G270	22
PL1238150	16	PL1248300	26	PL1256320	26	PL1300G300	22
PL1238185	16	PL1248320	26	PL1290090	40	PL1300G320	22
PL1238200	16	PL1249070	26	PL1290110	40	PL1300G350	22
PL1238240	16	PL1249090	26	PL1290125	40	PL1300G400	22
PL1238250	16	PL1249110	26	PL1290150	40	PL1300G450	22
PL1238270	16	PL1249125	26	PL1290185	40	PL1300G500	22
PL1238320	16	PL1249150	26	PL1290200	40	PL1300G650	22
PL1240070	16	PL1249185	26	PL1290240	40	PL1300G800	22
PL1240090	16	PL1249200	26	PL1290270	40	PL1303070	22
PL1240110	16	PL1249240	26	PL1290320	40	PL1303090	22
PL1240125	16	PL1249250	26	PL1297090	38	PL13031000	22
PL1240150	16	PL1249270	26	PL1297110	38	PL1303110	22
PL1240185	16	PL1249300	26	PL1297125	38	PL1303125	22
PL1240200	16	PL1249320	26	PL1297150	38	PL1303130	22
PL1240240	16	PL1250070	26	PL1297185	38	PL1303150	22
PL1240250	16	PL1250090	26	PL1297240	38	PL1303185	22
PL1240270	16	PL1250110	26	PL1297270	38	PL1303200	22
PL1240320	16	PL1250125	26	PL1297400	38	PL1303240	22
PL1242070	16	PL1250150	26	PL1297500	38	PL1303250	22
PL1242090	16	PL1250185	26	PL1299070	42	PL1303270	22
PL1242110	16	PL1250200	26	PL1299090	42	PL1303300	22
PL1242125	16	PL1250240	26	PL1299110	42	PL1303320	22
PL1242150	16	PL1250250	26	PL1299125	42	PL1303350	22
PL1242185	16	PL1250270	26	PL1299150	42	PL1303400	22
PL1242200	16	PL1250300	26	PL1299185	42	PL1303450	22
PL1242240	16	PL1250320	26	PL1299200	42	PL1303500	22
PL1242250	16	PL1252070	26	PL1299240	42	PL1303650	22
PL1242270	16	PL1252090	26	PL1299270	42	PL1303800	22
PL1242320	16	PL1252110	26	PL1299320	42	PL1318070	22
PL1244070	16	PL1252125	26	PL1300070	22	PL1318090	22
PL1244090	16	PL1252150	26	PL1300090	22	PL13181000	22
PL1244110	16	PL1252185	26	PL13001000	22	PL1318110	22
PL1244125	16	PL1252200	26	PL1300110	22	PL1318125	22
PL1244150	16	PL1252240	26	PL1300125	22	PL1318130	22
PL1244185	16	PL1252250	26	PL1300130	22	PL1318150	22

Code	Page	Code	Page	Code	Page	Code	Page
PL1318185	22	PL2235250	20	PN1235055	16	PN1242320	16
PL1318200	22	PL2235270	20	PN1235070	16	PN1244025	16
PL1318240	22	PL2235320	20	PN1235090	16	PN12440425	16
PL1318250	22	PL2240070	20	PN1235110	16	PN1244047	16
PL1318270	22	PL2240090	20	PN1235125	16	PN1244050	16
PL1318300	22	PL2240110	20	PN1235150	16	PN1244055	16
PL1318320	22	PL2240125	20	PN1235185	16	PN1244070	16
PL1318350	22	PL2240150	20	PN1235200	16	PN1244090	16
PL1318400	22	PL2240185	20	PN1235240	16	PN1244110	16
PL1318450	22	PL2240200	20	PN1235250	16	PN1244125	16
PL1318500	22	PL2240240	20	PN1235270	16	PN1244150	16
PL1318650	22	PL2240250	20	PN1235320	16	PN1244185	16
PL1318800	22	PL2240270	20	PN1238025	16	PN1244200	16
PL1320070	22	PL2240320	20	PN12380425	16	PN1244240	16
PL1320090	22	PL2244070	20	PN1238047	16	PN1244250	16
PL13201000	22	PL2244090	20	PN1238050	16	PN1244270	16
PL1320110	22	PL2244110	20	PN1238055	16	PN1244320	16
PL1320125	22	PL2244125	20	PN1238070	16	PN1246025	16
PL1320130	22	PL2244150	20	PN1238090	16	PN12460425	16
PL1320150	22	PL2244185	20	PN1238110	16	PN1246047	16
PL1320185	22	PL2244200	20	PN1238125	16	PN1246050	16
PL1320200	22	PL2244240	20	PN1238150	16	PN1246055	16
PL1320240	22	PL2244250	20	PN1238185	16	PN1246070	16
PL1320250	22	PL2244270	20	PN1238200	16	PN1246090	16
PL1320270	22	PL2244320	20	PN1238240	16	PN1246110	16
PL1320300	22	PN1232025	16	PN1238250	16	PN1246125	16
PL1320320	22	PN1232025	16	PN1238270	16	PN1246150	16
PL1320350	22	PN12320425	16	PN1238320	16	PN1246185	16
PL1320400	22	PN12320425	16	PN12400125	16	PN1246200	16
PL1320450	22	PN1232047	16	PN12400127	16	PN1246240	16
PL1320500	22	PN1232047	16	PN1240025	16	PN1246250	16
PL1320650	22	PN1232050	16	PN12400425	16	PN1246270	16
PL1320800	22	PN1232050	16	PN1240047	16	PN1246320	16
PL1326070	22	PN1232055	16	PN1240050	16	PN1248025	26
PL1326090	22	PN1232055	16	PN1240055	16	PN1248047	26
PL13261000	22	PN1232070	16	PN1240070	16	PN1248050	26
PL1326110	22	PN1232070	16	PN1240090	16	PN1248055	26
PL1326125	22	PN1232090	16	PN1240110	16	PN1248070	26
PL1326130	22	PN1232090	16	PN1240125	16	PN1248090	26
PL1326150	22	PN1232110	16	PN1240150	16	PN1248110	26
PL1326185	22	PN1232110	16	PN1240185	16	PN1248125	26
PL1326200	22	PN1232125	16	PN1240200	16	PN1248150	26
PL1326240	22	PN1232125	16	PN1240240	16	PN1248185	26
PL1326250	22	PN1232150	16	PN1240250	16	PN1248200	26
PL1326270	22	PN1232150	16	PN1240270	16	PN1248240	26
PL1326300	22	PN1232185	16	PN1240320	16	PN1248250	26
PL1326320	22	PN1232185	16	PN1242025	16	PN1248270	26
PL1326350	22	PN1232200	16	PN12420425	16	PN1248300	26
PL1326400	22	PN1232200	16	PN1242047	16	PN1248320	26
PL1326450	22	PN1232240	16	PN1242050	16	PN1249025	26
PL1326500	22	PN1232240	16	PN1242055	16	PN1249047	26
PL1326650	22	PN1232250	16	PN1242070	16	PN1249050	26
PL1326800	22	PN1232250	16	PN1242090	16	PN1249055	26
PL2235070	20	PN1232270	16	PN1242110	16	PN1249070	26
PL2235090	20	PN1232270	16	PN1242125	16	PN1249090	26
PL2235110	20	PN1232320	16	PN1242150	16	PN1249110	26
PL2235125	20	PN1232320	16	PN1242185	16	PN1249125	26
PL2235150	20	PN1235025	16	PN1242200	16	PN1249150	26
PL2235185	20	PN12350425	16	PN1242240	16	PN1249185	26
PL2235200	20	PN1235047	16	PN1242250	16	PN1249200	26
PL2235240	20	PN1235050	16	PN1242270	16	PN1249240	26

Code	Page	Code	Page	Code	Page	Code	Page
PN1249250	26	PN1256185	26	PN1300050	22	PN1303320	22
PN1249270	26	PN1256200	26	PN1300055	22	PN1303350	22
PN1249300	26	PN1256240	26	PN1300070	22	PN1303400	22
PN1249320	26	PN1256250	26	PN1300090	22	PN1303450	22
PN1250025	26	PN1256270	26	PN13001000	22	PN1303500	22
PN1250047	26	PN1256300	26	PN1300110	22	PN1303650	22
PN1250050	26	PN1256320	26	PN1300125	22	PN1303800	22
PN1250055	26	PN1258025	26	PN1300130	22	PN1318047	22
PN1250070	26	PN1258047	26	PN1300150	22	PN1318050	22
PN1250090	26	PN1258050	26	PN1300185	22	PN1318055	22
PN1250110	26	PN1258055	26	PN1300200	22	PN1318070	22
PN1250125	26	PN1258070	26	PN1300240	22	PN1318090	22
PN1250150	26	PN1258090	26	PN1300250	22	PN13181000	22
PN1250185	26	PN1258110	26	PN1300270	22	PN1318110	22
PN1250200	26	PN1258125	26	PN1300300	22	PN1318125	22
PN1250240	26	PN1258150	26	PN1300320	22	PN1318130	22
PN1250250	26	PN1258185	26	PN1300350	22	PN1318150	22
PN1250270	26	PN1258200	26	PN1300400	22	PN1318185	22
PN1250300	26	PN1258240	26	PN1300450	22	PN1318200	22
PN1250320	26	PN1258250	26	PN1300500	22	PN1318240	22
PN1252025	26	PN1258270	26	PN1300650	22	PN1318250	22
PN1252047	26	PN1258300	26	PN1300800	22	PN1318270	22
PN1252050	26	PN1258320	26	PN1300G047	22	PN1318300	22
PN1252055	26	PN1284090	41	PN1300G050	22	PN1318320	22
PN1252070	26	PN1284110	41	PN1300G055	22	PN1318350	22
PN1252090	26	PN1284125	41	PN1300G070	22	PN1318400	22
PN1252110	26	PN1284150	41	PN1300G090	22	PN1318450	22
PN1252125	26	PN1284185	41	PN1300G1000	22	PN1318500	22
PN1252150	26	PN1284240	41	PN1300G110	22	PN1318650	22
PN1252185	26	PN1290090	40	PN1300G125	22	PN1318800	22
PN1252200	26	PN1290110	40	PN1300G130	22	PN1320047	22
PN1252240	26	PN1290125	40	PN1300G150	22	PN1320050	22
PN1252250	26	PN1290150	40	PN1300G185	22	PN1320055	22
PN1252270	26	PN1290185	40	PN1300G200	22	PN1320070	22
PN1252300	26	PN1290200	40	PN1300G240	22	PN1320090	22
PN1252320	26	PN1290240	40	PN1300G250	22	PN13201000	22
PN1254025	26	PN1290270	40	PN1300G270	22	PN1320110	22
PN1254047	26	PN1290320	40	PN1300G300	22	PN1320125	22
PN1254050	26	PN1297090	38	PN1300G320	22	PN1320130	22
PN1254055	26	PN1297110	38	PN1300G350	22	PN1320150	22
PN1254070	26	PN1297125	38	PN1300G400	22	PN1320185	22
PN1254090	26	PN1297150	38	PN1300G450	22	PN1320200	22
PN1254110	26	PN1297185	38	PN1300G500	22	PN1320240	22
PN1254125	26	PN1297240	38	PN1300G650	22	PN1320250	22
PN1254150	26	PN1297270	38	PN1300G800	22	PN1320270	22
PN1254185	26	PN1297400	38	PN1303047	22	PN1320300	22
PN1254200	26	PN1297500	38	PN1303050	22	PN1320320	22
PN1254240	26	PN1299047	42	PN1303055	22	PN1320350	22
PN1254250	26	PN1299050	42	PN1303070	22	PN1320400	22
PN1254270	26	PN1299055	42	PN1303090	22	PN1320450	22
PN1254300	26	PN1299070	42	PN13031000	22	PN1320500	22
PN1254320	26	PN1299090	42	PN1303110	22	PN1320650	22
PN1256025	26	PN1299110	42	PN1303125	22	PN1320800	22
PN1256047	26	PN1299125	42	PN1303130	22	PN1326047	22
PN1256050	26	PN1299150	42	PN1303150	22	PN1326050	22
PN1256055	26	PN1299185	42	PN1303185	22	PN1326055	22
PN1256070	26	PN1299200	42	PN1303200	22	PN1326070	22
PN1256090	26	PN1299240	42	PN1303240	22	PN1326090	22
PN1256110	26	PN1299270	42	PN1303250	22	PN13261000	22
PN1256125	26	PN1299320	42	PN1303270	22	PN1326110	22
PN1256150	26	PN1300047	22	PN1303300	22	PN1326125	22

Code	Page	Code	Page	Code	Page	Code	Page
PN1326130	22	PN2244090	20	RL916LR	66	TP14LF	62
PN1326150	22	PN2244110	20	RL925	66	TP14P	62
PN1326185	22	PN2244125	20	RL926	66	TP15	62
PN1326200	22	PN2244150	20	RM13054252	32	TP15DD	62
PN1326240	22	PN2244185	20	RM13054252	32	TP15E	62
PN1326250	22	PN2244200	20	RM13055050	32	TP15F	62
PN1326270	22	PN2244240	20	RM13055252	32	TP15P	62
PN1326300	22	PN2244250	20	RM13055858	32	TP15P largo	62
PN1326320	22	PN2244270	20	RM15033242	32	TP15PB	62
PN1326350	22	PN2244320	20	RM15034252	32	TP16	62
PN1326400	22	PN516G075	56	RM15035050	32	TP17	62
PN1326450	22	PN516G085	56	RM15035252	32	TP18	62
PN1326500	22	PN516G088	56	RM15035858	32	TP18 largo	62
PN1326650	22	PN516G090	56	RM15053242	33	TP18D	62
PN1326800	22	PN516G095	56	RM15054252	33	TP18P	62
PN1860110	55	PN516G130	56	RM15054657	33	TP19	62
PN1860130	55	PN516G160	56	RM15055050	33	TP20	62
PN1860150	55	PN518G075	56	RM15083242	33	TP20A	62
PN1860160	55	PN518G085	56	RM15084252	33	TP20M	62
PN1860170	55	PN518G088	56	RM15084657	33	TP20P	62
PN1860190	55	PN518G090	56	RM15085050	33	TP21,5	62
PN1860200	55	PN518G095	56	RM15103242	32	TP22 corto	62
PN1860240	55	PN518G130	56	RM15104252	32	TP22 largo	62
PN2235025	20	PN518G160	56	RM15105050	32	TP23,5P	62
PN22350425	20	PNNW25L050	43	RM15105252	32	TP26	62
PN2235047	20	PNNW25L055	43	RM15105858	32	TP27	62
PN2235050	20	PNNW25L090	43	RM305G1160	56	TP29	62
PN2235055	20	PNNW25L110	43	RM305G4252	56	TP29A	62
PN2235070	20	PNNW25L125	43	RM516G3242	56	TP29K	62
PN2235090	20	PNNW25L150	43	RM516G4252	56	TP32	62
PN2235110	20	PNNW25L200	43	SMG47	159	TP32P	62
PN2235125	20	PNNW35L050	43	SPS47	159	TP32PD	62
PN2235150	20	PNNW35L055	43	SS100	161	TP34	62
PN2235185	20	PNNW35L090	43	SS500	161	TP36	62
PN2235200	20	PNNW35L110	43	SSSP47	161	TP37	62
PN2235240	20	PNNW35L125	43	STP16	164	TP38	62
PN2235250	20	PNNW35L150	43	STP8	159, 160, 161, 162,	TP4	62
PN2235270	20	PNNW35L200	43	TG-10	156	TP40P	62
PN2235320	20	PNNW65L050	43	TMBNC022/30300	90	TP45P	62
PN2240025	20	PNNW65L055	43	TMBNC045/30300	90	TP5S	62
PN22400425	20	PNNW65L090	43	TMBNY022/30300	90	TP5SK	62
PN2240047	20	PNNW65L110	43	TMBNY045/30300	90	TP6F	62
PN2240050	20	PNNW65L125	43	TMBPV022/30300	90	TP7	62
PN2240055	20	PNNW65L150	43	TMBPV045/30300	90	TP7D	62
PN2240070	20	PNNW65L200	43	TMNC0222020	90	TP8	62
PN2240090	20	PNS450025R	58	TMNC0452020	90	TP8P	62
PN2240110	20	RC1200581010	68	TMNY0222020	90	TP9	62
PN2240125	20	RC1200702315	68	TMNY0452020	90	TP9D	62
PN2240150	20	RF-NY1	148	TMPV0222020	90	TP9K	62
PN2240185	20	RF-NY3	148	TMPV0452020	90	TP9P	62
PN2240200	20	RF-NY6	148	TP10	62	TR12288150	72
PN2240240	20	RL120025300/D	69	TP11	62	TR143940100	70
PN2240250	20	RL120029300/D	70	TP12	62	TR1911F01	66
PN2240270	20	RL120040300/D	70	TP12,5	62	TR1911F02	66
PN2240320	20	RL1911R01	66	TP12P	62	TR1911F03	66
PN2244025	20	RL1911R02	66	TP13	62	TR1911F04	66
PN22440425	20	RL1911R03	66	TP13,5P	62	TR1911F05	66
PN2244047	20	RL1911R04	66	TP13H	62	TR1911F06	66
PN2244050	20	RL1911R05	66	TP14	62	TR1911F07	66
PN2244055	20	RL1911R06	66	TP14,5	62	TR1911F08	66
PN2244070	20	RL916LB	66	TP14LD	62	TR1911F09	66

Code	Page
TR1911F10	66
TR1911F11	66
TR1911F12	66
TR519G18320	56
TR519G30200	56
TR555G	56
TR556G	56
TR916LB	56
TR916LR	56
TR925	56
TR926	56
TS-RNY	148
TV-100	146
VB-1200	164
VB-3000	164
VFPE022250B	144
VFPE0222500	144
VFPE022500B	144
VFPE045250B	144
VFPE045500	144
VFPE045500B	144
VFPVDF022250B	144
VFPVDF022500	144
VFPVDF022500B	144
VFPVDF045250B	144
VFPVDF045500	144
VFPVDF045500B	144
WV100	159, 169, 161, 162, 163, 164
WV100-8	159, 160, 161, 163

Ordering of FILTER-LAB® products

All products contained in this catalog can be ordered through our network of laboratory material distributors in more than 100 countries around the world. As a user, if you have not registered any distributor, you can contact our commercial office to know the closest to your location.

You can also request more technical information from our Technical-Commercial Department:

FILTROS ANOIA, S.A.

C/Cami de Baix, s/n
08776 Sant Pere Riudebitlles (Barcelona) SPAIN
Tel. +34.93.8995036
Fax +34.93.8997172
fanoia@fanoia.com
www.fanoia.com
Skype: antonio.fanoia

About the contents of this catalog



All the applications indicated in this product catalog are just examples of use of possible uses after many years of experience. It is therefore advisable to evaluate in each case the characteristics of the sample or liquid to be filtered and also the conditions of use.

There is a version of this catalog in Spanish, which you can request from our Commercial Department.

Any partial or total reproduction of the content: images, text, graphics or trademarks, is forbidden without the express written authorization of FILTROS ANOIA, S.A.

Technical specifications, formats and product presentations are subject to change without notice.

Digital edition finalized in July 2017. Barcelona

About FILTER-LAB®

FILTER-LAB® is a registered trademark owned by FILTROS ANOIA, S.A.





Especialistas en productos para la Filtración, Microfiltración y Separación en laboratorio



FILTROS ANOIA, S.A.
 Camí de Baix, s/n
 08776 Sant Pere Riudebitlles (Barcelona) ESPAÑA
 Tel. +34.93.8995036
 Fax +34.93.8997172
 E-mail: fanoia@fanoia.com
 web: fanoia.com

